

# KOHLER®

**Avec®**  
60" x 42" drop-in bath  
**K-25833**

## Features

- Slotted overflow allows for deep soaking
- 13-1/4" (337 mm) deep-soaking depth provides a relaxing bathing experience
- Integral lumbar support and neck rest offer extra comfort while bathing
- Low step-over height allows easy entry and exit
- Integral overflow reduces installation time
- Toe-tap drain color-matched to the bath
- Textured bottom surface

## Material

- Acrylic

## Installation

- Drop-in
- Reversible drain



**ADA**

## Codes/Standards

CSA B45.5/IAPMO Z124  
ASTM E162  
ASTM E662  
ADA  
ICC/ANSI A117.1

## **KOHLER® Plastic Baths and Shower Bases Lifetime Limited Warranty**

See website for detailed warranty information.

1-800-4KOHLER (1-800-456-4537)

Kohler Co. reserves the right to make revisions without notice to product specifications.

For the most current Specification Sheet, go to [www.kohler.com](http://www.kohler.com) USA or [www.kohler.ca](http://www.kohler.ca) Canada

12-11-2025 22:22 - US

THE BOLD LOOK  
OF **KOHLER®**

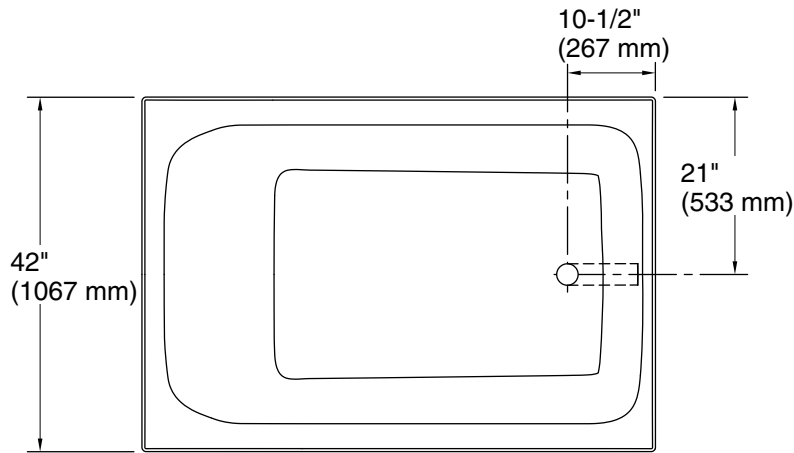

No change in measurements if connected with drain illustrated. (1475082)

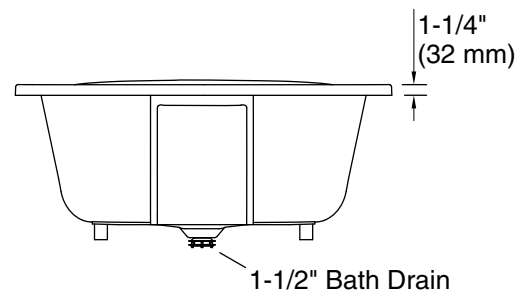
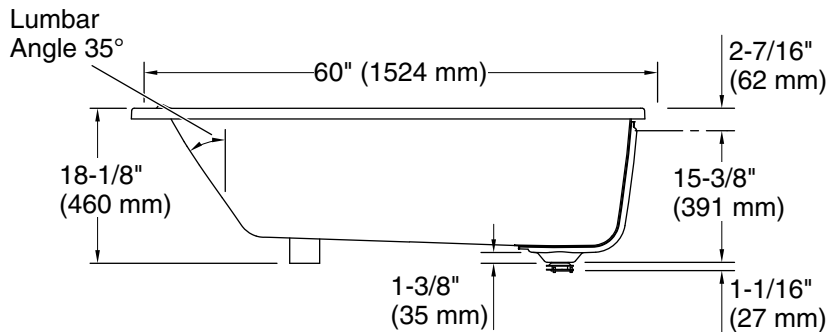
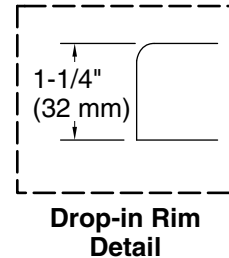

## Technical Information

All product dimensions are nominal.

Drain location:	Reversible
Basin area, bottom:	43-1/2" x 30-13/16" (1105 mm x 783 mm)
Basin area, top:	55-15/16" x 35-1/2" (1421 mm x 901 mm)
Weight:	125.48 lbs (56.9 kg)
Minimum floor load:	45.4 lbs/ft <sup>2</sup> (221.7 kg/m <sup>2</sup> )
Water depth:	13-1/4" (337 mm)
Water capacity:	80.3 gal (304 L)
Minimum flat for door:	2-15/16" (75 mm)

## Notes

Measure your actual product for rough-in details.

Install this product according to the installation instructions.

The hot water supply should be 70% of the capacity of the bath or greater. Installations will vary.

ADA compliant when installed to the specific requirements of these regulations.