

Features

- Single-speed whirlpool offers performance and value, with six fully adjustable jets
- Hydromassage flow and direction can be controlled at each jet
- Built-in heater
- Generous length provides a spacious bathing area
- Hourglass shape adds style and elegance to your bathroom
- Integral flange helps prevent water from seeping behind wall and simplifies alcove installation
- Textured bottom surface

Material

- Acrylic

Hydrotherapy

- Whirlpool

Installation

- Right drain
- Alcove

Required Products/Accessories

K-T37391 Rotary-turn bath drain trim
K-T37392 Rotary-turn bath drain trim

or

K-37383 Rough-in cable bath drain, PVC, 30" cable with tubing
K-78438 30" cable bath drain

Recommended Products/Accessories

K-1491 Bath/Whirlpool Pillow
K-23726 Drain treatment
K-23732 Tub & shower cleaner
K-7265 Brass toe tap bath drain
K-31796 Above-the-floor bath drain kit
K-31798 Bath drain kit



Codes/Standards

ASME A112.19.7/CSA B45.10
CSA B45.5/IAPMO Z124
ASTM E162
ASTM E662
UL 1795
IAPMO Certification
UL Listed



KOHLER® Plastic Baths and Shower Bases Lifetime Limited Warranty KOHLER® Hydrotherapy Components Five-Year Limited Warranty

See website for detailed warranty information.

Available Colors/Finishes

Color tiles intended for reference only.

Color	Code	Description
-------	------	-------------

	0	White
	96	Biscuit

No change in measurements if connected with drain illustrated. (K-11677)

 Recommended Faucet Location

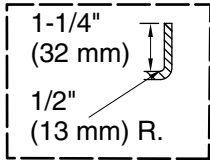

Integral Flange Detail

Pump/Control Access (If Apron Is Not Used):
20" (508 mm) W x 15" (381 mm) H

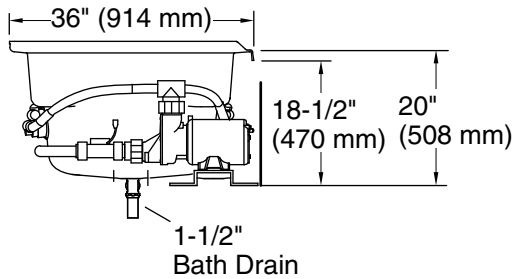

Pump/Control Access
(If Apron Is Not Used)
20" (508 mm) W x 15" (381 mm) H

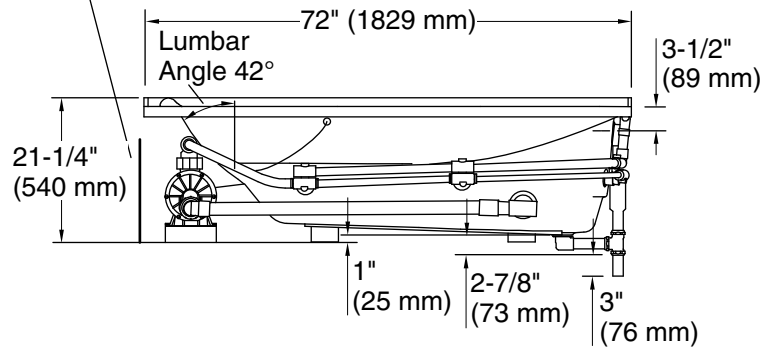
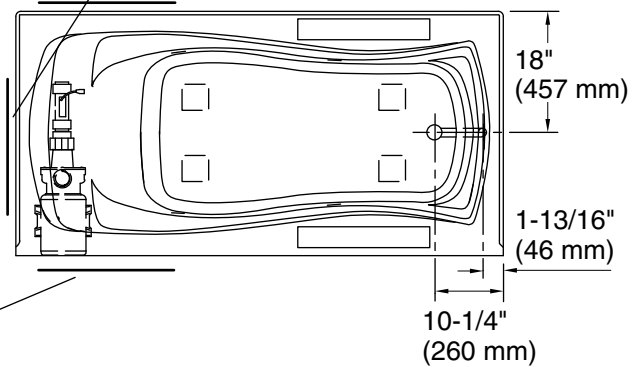

Required Electrical Service

Two dedicated circuits required, protected with Class A Ground-Fault Circuit-Interrupter (GFCI). Outside North America, this device may be known as a Residual Current Device (RCD).

Pump: 120 V, 15 A, 60 Hz
Heater: 120 V, 15 A, 60 Hz

Technical Information

All product dimensions are nominal.

Drain location: Right
Basin area, bottom: 50" x 24" (1270 mm x 610 mm)
Basin area, top: 65" x 27" (1651 mm x 686 mm)
Weight: 115 lbs (52.2 kg)
Minimum floor load: 41 lbs/ft² (200.2 kg/m²)
Water depth: 14" (356 mm)
Water capacity: 72 gal (272.5 L)
Electrical component rating: Pump: 120 V, 7.5 A, 60 Hz
Heater: 120 V, 12.5 A, 60 Hz, 1500 W
Pump speed: Single

Notes

Measure your actual product for rough-in details.

Install this product according to the installation instructions.

The hot water supply should be 70% of the capacity of the bath or greater. Installations will vary.

If installing a rim-mount faucet, make sure there is no interference above or below the deck before drilling any holes.