

Features

- Kinesis® technology with concealed sensor allows for a clean aesthetic and provides extraordinarily accurate and reliable actuation in varying installation environments
- Below-counter valving reduces the faucet footprint and provides easier service
- Design-forward aesthetic for commercial bathroom spaces
- 0.5 gpm (1.9 lpm) maximum flow rate
- Powered by a 30 year/875,000 cycle hybrid energy cell, based on 72 uses per day
- On-demand usage with 30-second max. continual run cycle to prevent vandalism and save water
- Vandal-resistant aerator
- 18" (457 mm) stainless steel braided flexible supply hose for easy installation
- 6-5/8" (168 mm) spout reach
- Includes spout assembly, grid drain, control box assembly, mechanical mixer, hybrid energy cell, supply hose, and standard mounting hardware
- Complies with the Safe Drinking Water Act (SDWA)

Material

- Brass construction spout

Technology

- Kinesis® sensor technology offers on-demand detection for maximum water savings

Installation

- Single-hole mounting

Included Components

K-7129-A Drain



ADA

CSA B651

OBC

Codes/Standards

ASME A112.18.1/CSA B125.1

NSF/ANSI/CAN 61

NSF/ANSI/CAN 372

All applicable US Federal and State material regulations

DOE - Energy Policy Act 1992

California Energy Commission (CEC)

ADA

ICC/ANSI A117.1

CSA B651

OBC

IAPMO Certification

KOHLER® One-Year Limited Warranty

See website for detailed warranty information.

Available Colors/Finishes

Color tiles intended for reference only.

Color	Code	Description
-------	------	-------------



CP

Polished Chrome

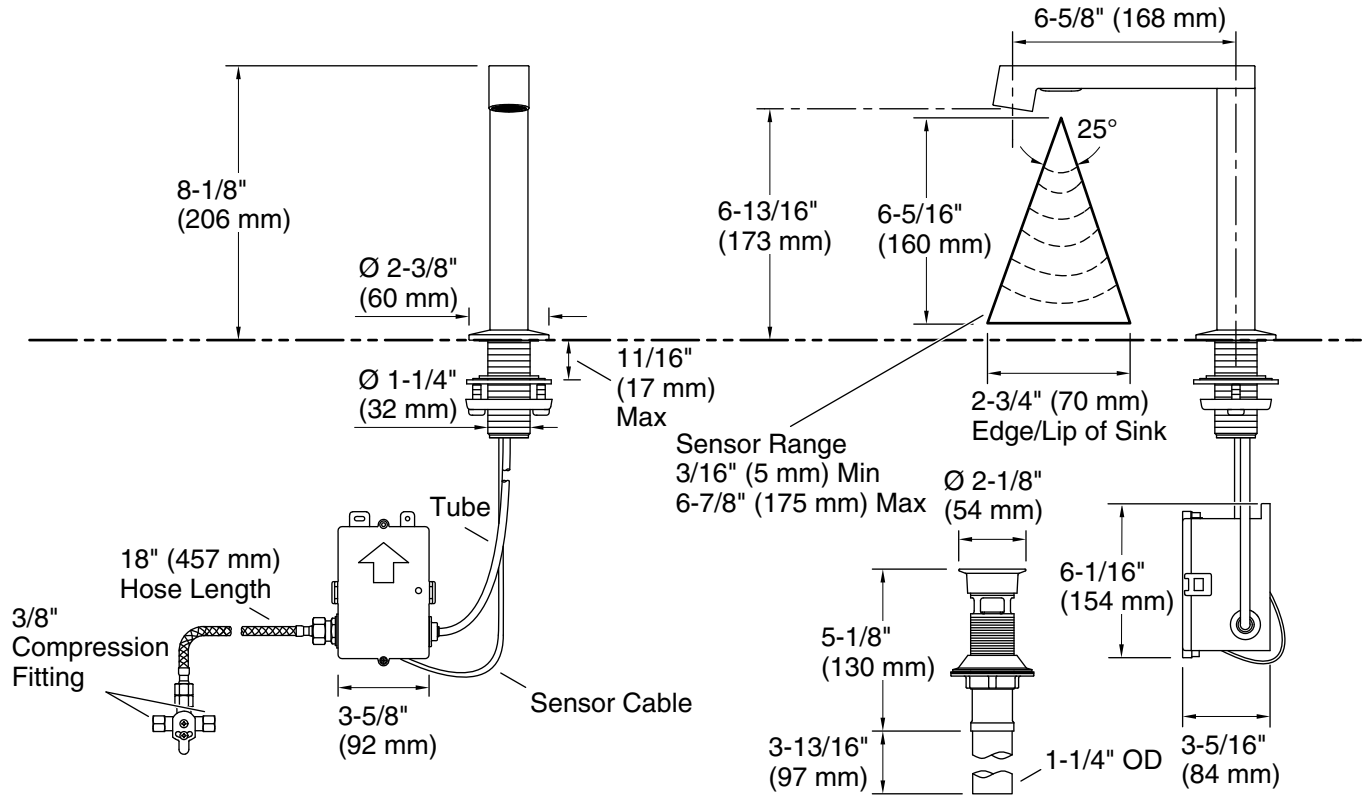

Technical Information

All product dimensions are nominal.

Power source: Hybrid Energy Cell, included

Faucet:

Flow rate: 0.5 gal/min (1.9 l/min)

Pressure: 60 psi (4.1 bar)

Drain included: Yes

Drain with overflow: Yes

Spout:

Spout reach: 6-5/8" (168 mm)

Pressure/fixture Supply Requirements

Fixture pressure max (static): 125 psi (861.8 kPa)

Fixture pressure min (static): 20 psi (137.9 kPa)

Notes

Install this product according to the installation instructions.

ADA, OBC, CSA B651 compliant when installed to the specific requirements of these regulations.