

Features

- Frameless design emphasizes glass and creates a sleek, minimalist look
- Vertical handle with inside knob on moving panel
- Gently-curved towel bar provides integrated storage on fixed panel
- Tempered glass ensures enhanced safety and durability
- CleanCoat®+ glass coating creates a hydrophobic barrier that repels water, soap scum, and residue, saving time and protecting shower doors 10 times longer than original CleanCoat. (Based on 2021 internal wear/abrasion testing using a microfiber cloth.)
- Smooth, easy-to-clean wall jambs
- Full-length moving panel seal provides excellent water containment
- Coordinates with other products in the Elate collection
- Shower door configuration consists of one sliding panel and one stationary panel

Material

- Frameless, heavy 5/16" (8 mm) thick Crystal Clear tempered glass with frosted privacy band
- Anodized aluminum prevents rust and corrosion

Installation

- Fits opening widths 68-1/4" - 71-5/8" (1734 - 1819 mm)
- 75-1/2" (1918 mm) tall, with a lofty 72-11/16" (1846 mm) minimum head clearance
- 3-3/8" (86 mm) width adjustment
- Out-of-plumb adjustability simplifies installation
- Door can be installed to open to the left or right to suit your bathroom layout
- For residential use only
- Not for use in hospitality



Codes/Standards

ANSI Z97.1
CAN/CGSB-12.1
CPSC 16CFR 1201

KOHLER® Bath and Shower Doors Ten-Year Limited Warranty

See website for detailed warranty information.

Available Colors/Finishes

Color tiles intended for reference only.

Color	Code	Description
	SH	Bright Silver
	MX	Matte Nickel
	BL	Matte Black

Available Glass Options

Code	Description
G81	Crystal Clear with Frosted Privacy Band

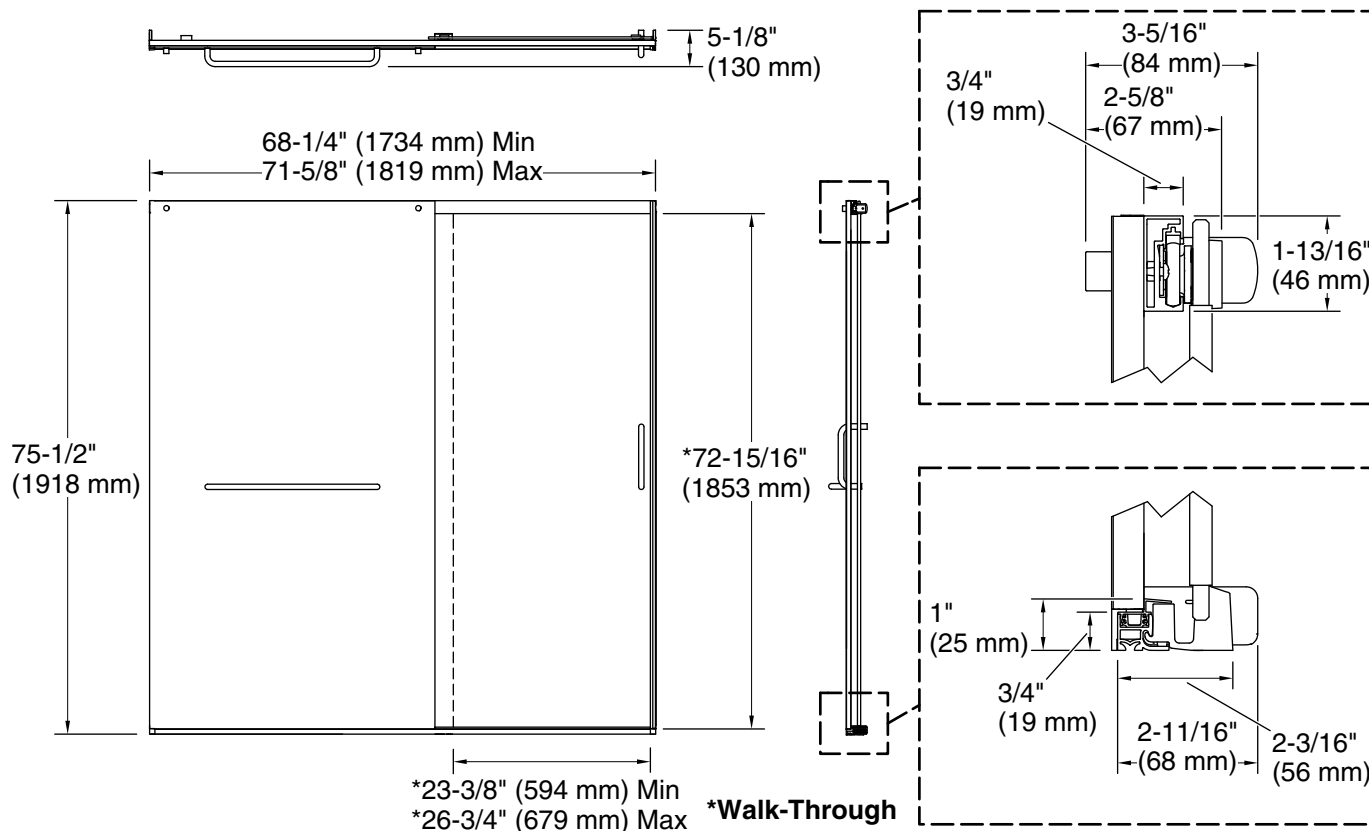

Technical Information

All product dimensions are nominal.

Base-To-Wall	1/2" (13 mm)
Radius – Max:	
Shower Ledge Min	2-1/4" (57 mm)
Flat:	
Shower Wall Min	2-7/8" (73 mm)
Flat:	

Notes

Install this product according to the installation instructions.

The vertical opening should be a minimum of 78-13/16" (2002 mm) to allow for installation clearance.