

## Features

- Frameless design emphasizes glass and creates a sleek, minimalist look
- Vertical handle with inside knob on moving panel
- Tempered glass ensures enhanced safety and durability
- CleanCoat®+ glass coating creates a hydrophobic barrier that repels water, soap scum, and residue, saving time and protecting shower doors 10 times longer than original CleanCoat. (Based on 2021 internal wear/abrasion testing using a microfiber cloth.)
- Smooth, easy-to-clean wall jambs
- Full-length moving panel seal provides excellent water containment
- Controlled Close® innovative soft-close with double-dampening technology eliminates slamming and brings door to a secure close
- Shower door configuration consists of one sliding panel and one stationary panel
- Coordinates with other products in the Rely collection

## Material

- Frameless, 3/8" (10 mm) thick Frosted tempered glass with easy-to-clean rectangular grille design imprinted on surface
- Anodized aluminum prevents rust and corrosion

## Installation

- Fits opening widths 56-5/8" – 59-5/8" (1438 –1514 mm)
- 77" (1956 mm) high, with a lofty 73-7/8" (1876 mm) minimum head clearance
- 3" (76.2 mm) width adjustment
- Out-of-plumb adjustability simplifies installation
- Door can be installed to open to the left or right to suit your bathroom layout
- For residential use only
- Not for use in hospitality



## Codes/Standards

ANSI Z97.1  
CAN/CGSB-12.1  
CPSC 16CFR 1201

## KOHLER® Bath and Shower Doors Ten-Year Limited Warranty

See website for detailed warranty information.

## Available Colors/Finishes

*Color tiles intended for reference only.*

Color	Code	Description
■	BL	Matte Black

## Available Glass Options

Code	Description
G80	Frosted with Rectangular Grille Pattern

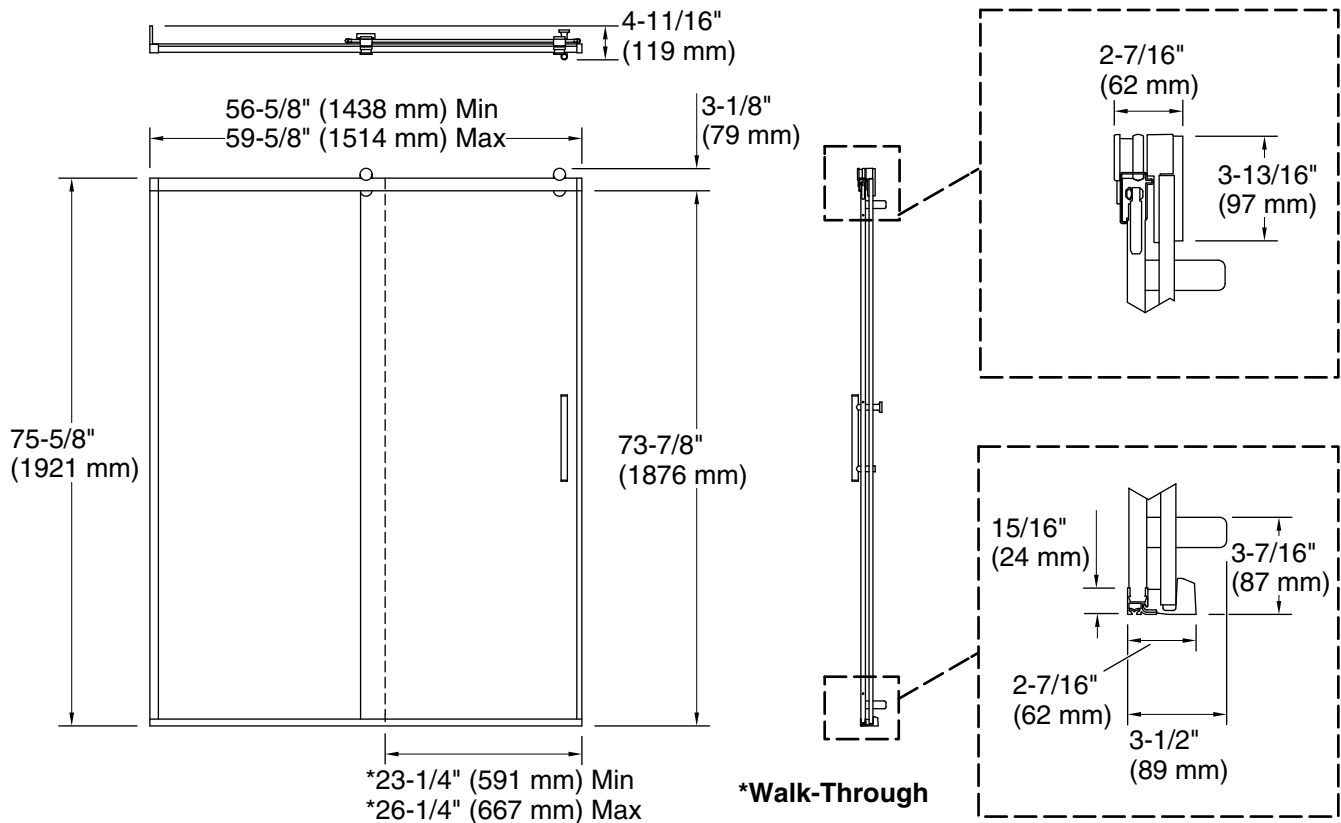

## Technical Information

All product dimensions are nominal.

Base-To-Wall	1/2" (13 mm)
Radius – Max:	
Shower Ledge Min	2-1/2" (64 mm)
Flat:	
Shower Wall Min	3-1/2" (89 mm)
Flat:	

## Notes

Install this product according to the installation guide.

The vertical opening should be a minimum of 78-1/2" (1994 mm) to allow for installation clearance.