

Features

- Bask® heated surface creates spa-like relaxation with soothing warmth on your back, shoulders, and neck
- Three heat settings allow you to customize the surface temperature
- Single-speed whirlpool offers performance and value with 8 fully adjustable jets
- Hydromassage flow and direction can be controlled at each jet
- Comfort Depth® design offers a convenient 19" step-over height while retaining the same depth as a standard 21" bath
- Integral lumbar support and armrests offer extra comfort while bathing
- Slotted overflow allows for deep soaking
- Textured bottom surface
- Integral apron
- Integral flange helps prevent water from seeping behind wall and simplifies alcove installation
- Coordinates with other products in the Archer collection

Material

- Acrylic

Hydrotherapy

- Whirlpool

Installation

- Left drain
- Alcove

Required Products/Accessories

K-7271 Brass Slotted Overflow Bath Drain

or

K-7272 PVC Slotted Overflow Bath Drain

Recommended Products/Accessories

K-23726 Drain treatment

K-23732 Tub & shower cleaner

K-31797 Slotted overflow bath drain kit

K-31795 Slotted overflow above-the-floor bath drain kit



ADA

Codes/Standards

ASME A112.19.7/CSA B45.10

CSA B45.5/IAPMO Z124

UL 1795

CSA C22.2 No. 218.2

ADA

ICC/ANSI A117.1

IAPMO Certification

cUL Listed







UL Listed

KOHLER® Plastic Baths and Shower Bases Lifetime Limited Warranty KOHLER® Hydrotherapy Components Five-Year Limited Warranty

See website for detailed warranty information.

Available Colors/Finishes

Color tiles intended for reference only.

Color	Code	Description
	0	White
	96	Biscuit
	NY	Dune
	95	Ice™ Grey
	58	Thunder™ Grey
	7	Black Black™

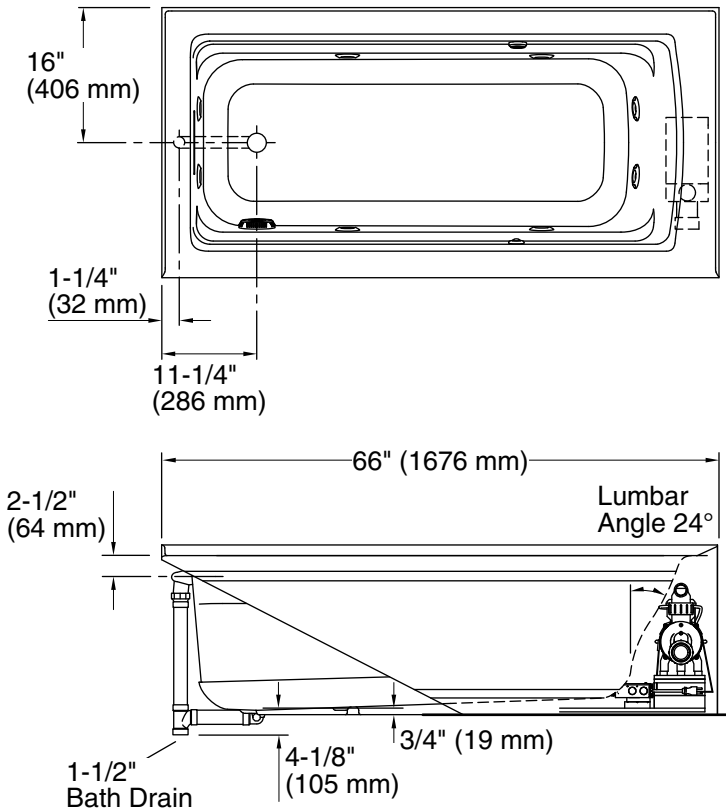

No change in measurements if connected with drain illustrated. (K-7272)

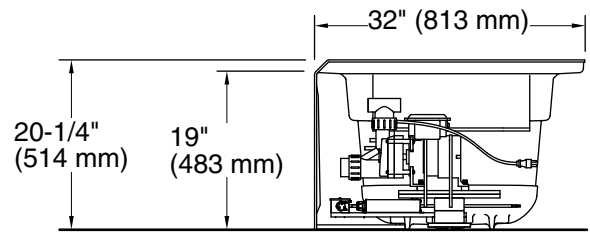
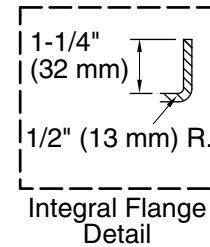

Required Electrical Service

One dedicated circuit required, protected with Class A Ground-Fault Circuit-Interrupter (GFCI). Outside North America, this device may be known as a Residual Current Device (RCD).

Pump, Heated Surface: 120 V, 15 A, 60 Hz

Technical Information

All product dimensions are nominal.

Drain location: Left
 Basin area, bottom: 50-3/8" x 19-5/8" (1280 mm x 498 mm)
 Basin area, top: 57-5/16" x 24-1/16" (1456 mm x 611 mm)
 Weight: 130 lbs (59 kg)
 Minimum floor load: 48.1 lbs/ft² (234.8 kg/m²)
 Water depth: 15-5/16" (389 mm)
 Water capacity: 66 gal (249.8 L)
 Electrical component rating: Pump: 120 V, 7 A, 60 Hz
 Heated Surface: 120 V, 0.5 A, 60 Hz, 65 W
 Pump speed: Single

Notes

Measure your actual product for rough-in details.

Install this product according to the installation instructions.

The hot water supply should be 70% of the capacity of the bath or greater. Installations will vary.

ADA compliant when installed to the specific requirements of these regulations.