

Features

- 118 airjets release thousands of heated bubbles that surround and support the body in a warm massage
- Automatic and manual purge cycles remove residual water from air channels after use
- Variable-speed blower lets you adjust Heated BubbleMassage™ massage intensity to 18 levels
- Single-speed whirlpool revitalizes sore muscles
- 8 fully adjustable whirlpool jets allow users to customize hydromassage flow and direction at each jet
- Comfort Depth® design offers a convenient 19" step-over height while retaining the same depth as a standard 21" bath
- Integral lumbar support
- Slotted overflow allows for deep soaking
- Integral apron
- Integral flange helps prevent water from seeping behind wall and simplifies alcove installation
- Textured bottom surface
- Coordinates with other products in the Archer collection
- Built-in 600W BubbleMassage™ heater warms humidified air before it enters the bath
- Automatic and manual purge cycles remove residual water from air channels after use

Material

- Acrylic

Hydrotherapy

- Whirlpool

Technology

- Auto-shutoff timer on blower allows users to enjoy Heated BubbleMassage™ experience for 60 minutes before turning off
- User interface: electronic keypad control for Heated BubbleMassage™; air switch actuator for whirlpool

Installation

- Left drain
- Alcove
- Remote blower motor installation required (relocation kit is included)

Required Products/Accessories

K-7271 Brass Slotted Overflow Bath Drain

or

K-7272 PVC Slotted Overflow Bath Drain

Recommended Products/Accessories



ADA

Codes/Standards







ASME A112.19.7/CSA B45.10
CSA B45.5/IAPMO Z124
ASTM E162
ASTM E662
UL 1795
CSA C22.2 No. 218.2
ADA
ICC/ANSI A117.1
IAPMO Certification
cUL Listed
UL Listed

KOHLER® Hydrotherapy Components Five-Year Limited Warranty KOHLER® Plastic Baths and Shower Bases Lifetime Limited Warranty

See website for detailed warranty information.

Available Colors/Finishes

Color tiles intended for reference only.

Color	Code	Description
	0	White
	96	Biscuit
	NY	Dune
	95	Ice™ Grey
	58	Thunder™ Grey
	7	Black Black™

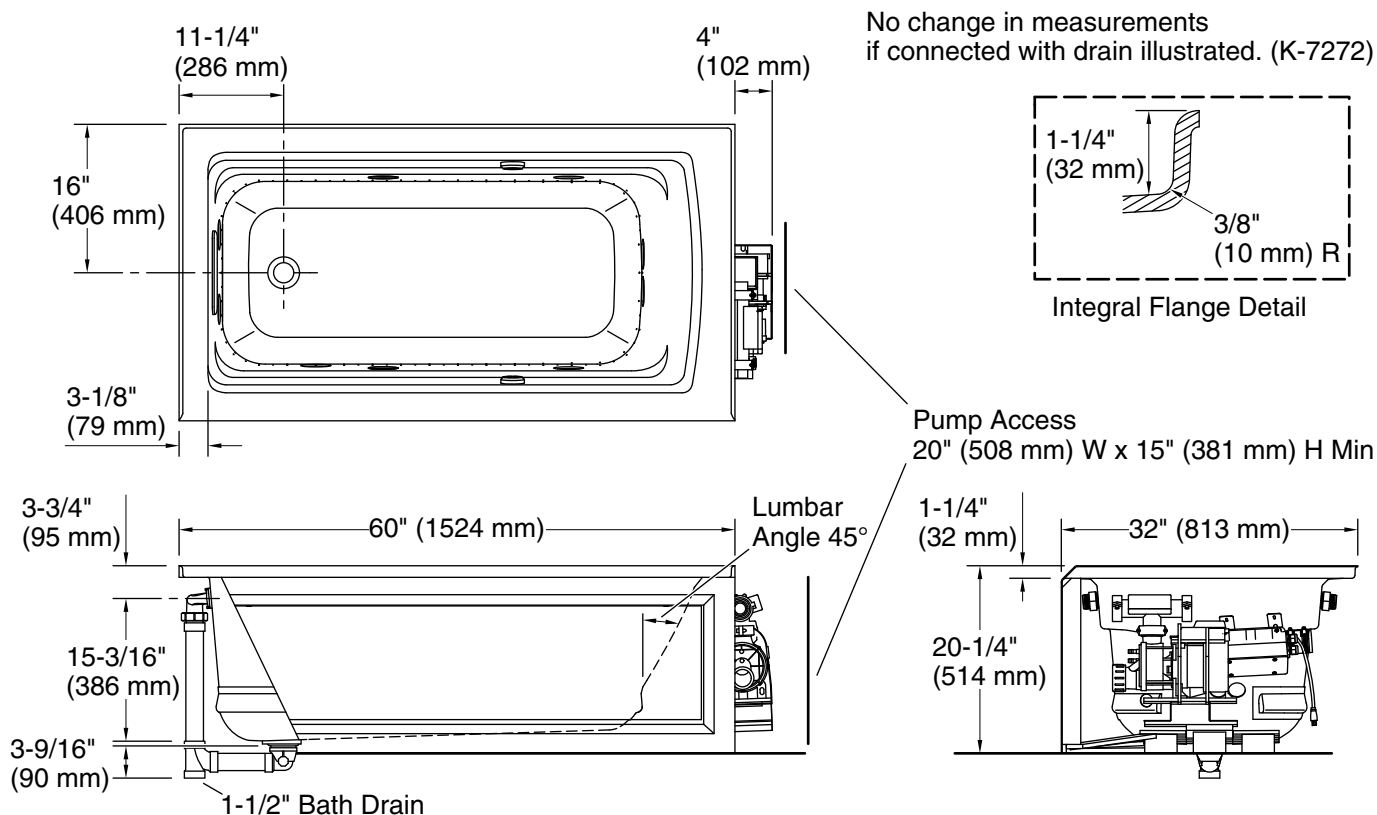

Required Electrical Service

Three dedicated circuits required, protected with Class A Ground-Fault Circuit-Interrupter (GFCI). Outside North America, this device may be known as a Residual Current Device (RCD).

Pump, Heater: 120 V, 15 A, 60 Hz

Heater: 120 V, 15 A, 60 Hz

Blower: 120 V, 15 A, 60 Hz

Technical Information

All product dimensions are nominal.

Drain location: Left

Basin area, bottom: 45-1/8" x 19-11/16" (1146 mm x 500 mm)

Basin area, top: 52-3/4" x 25-5/16" (1340 mm x 643 mm)

Weight: 165 lbs (74.8 kg)

Minimum floor load: 52 lbs/ft² (253.9 kg/m²)

Water depth: 15" (381 mm)

Water capacity: 58 gal (219.6 L)

Electrical component Pump: 120 V, 7 A, 60 Hz

rating: Heater: 120 V, 5 A, 60 Hz

Heater: 120 V, 12 A, 60 Hz

Notes

Measure your actual product for rough-in details.

Install this product according to the installation instructions.

The hot water supply should be 70% of the capacity of the bath or greater. Installations will vary.

Remote blower installation kit is available for relocating the blower. Provide access for servicing the blower.

Do not relocate or alter the PVC tee or coiled flexible tubing connected to the blower. Follow the blower relocation instructions exactly.

ADA compliant when installed to the specific requirements of these regulations.