

## Features

- Bask® heated surface creates spa-like relaxation with soothing warmth on your back, shoulders, and neck
- Three heat settings allow you to customize the surface temperature
- Single-speed whirlpool offers performance and value with 8 fully adjustable jets
- Hydromassage flow and direction can be controlled at each jet
- Comfort Depth® design offers a convenient 19" step-over height while retaining the same depth as a standard 21" bath
- Integral lumbar support
- Slotted overflow allows for deep soaking
- Integral apron
- Integral flange helps prevent water from seeping behind wall and simplifies alcove installation
- Textured bottom surface
- Coordinates with other products in the Archer collection

## Material

- Acrylic

## Installation

- Left drain
- Alcove

## Required Products/Accessories

K-7271 Brass Slotted Overflow Bath Drain

or

K-7272 PVC Slotted Overflow Bath Drain

## Recommended Products/Accessories

K-23726 Drain treatment

K-23732 Tub & shower cleaner

K-31797 Slotted overflow bath drain kit

K-31795 Slotted overflow above-the-floor bath drain kit



**ADA**

## Codes/Standards

ASME A112.19.7/CSA B45.10

CSA B45.5/IAPMO Z124

ASTM E162

ASTM E662

UL 1795

CSA C22.2 No. 218.2

ADA

ICC/ANSI A117.1

IAPMO Certification

cUL Listed

UL Listed





**KOHLER® Hydrotherapy Components Five-Year Limited Warranty**  
**KOHLER® Plastic Baths and Receptors Lifetime Limited Warranty**  
**KOHLER® Enameled Cast Iron Bath and Shower Base Lifetime Limited Warranty**

See website for detailed warranty information.

## Available Colors/Finishes

*Color tiles intended for reference only.*

### Color Code Description

	0	White
	96	Biscuit
	NY	Dune
	95	Ice™ Grey

No change in measurements if connected with drain illustrated. (K-7272)

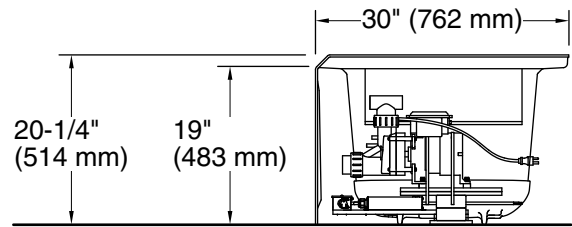
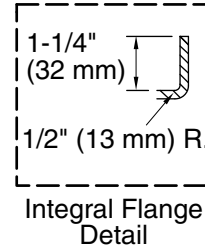
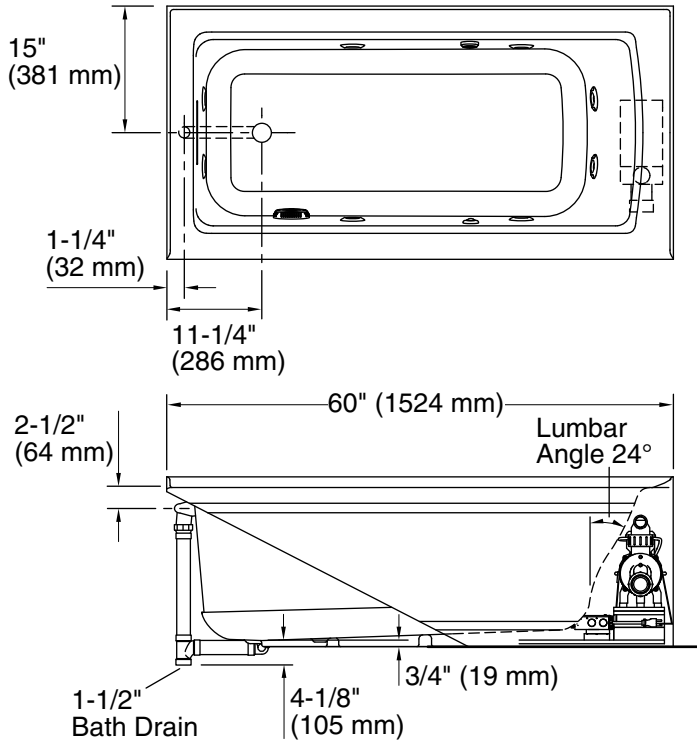

### Required Electrical Service

One dedicated circuit required, protected with Class A Ground-Fault Circuit-Interrupter (GFCI). Outside North America, this device may be known as a Residual Current Device (RCD).

Pump, Heated Surface: 120 V, 15 A, 60 Hz

### Technical Information

All product dimensions are nominal.

Drain location: Left  
 Basin area, bottom: 45-1/8" x 19-11/16" (1146 mm x 500 mm)  
 Basin area, top: 52-1/8" x 22-1/16" (1324 mm x 560 mm)  
 Weight: 123 lbs (55.8 kg)  
 Minimum floor load: 50 lbs/ft<sup>2</sup> (244.1 kg/m<sup>2</sup>)  
 Water depth: 15-1/8" (384 mm)  
 Water capacity: 57 gal (215.8 L)  
 Electrical component rating:  
 Pump: 120 V, 7 A, 60 Hz  
 Heated Surface: 120 V, 0.5 A, 60 Hz, 65 W  
 Minimum flat for: 2-9/16" (66 mm)

### Notes

Measure your actual product for rough-in details.

Install this product according to the installation instructions.

The hot water supply should be 70% of the capacity of the bath or greater. Installations will vary.

Provide one grounded electrical outlet within 24" (610 mm) of each component.

ADA compliant when installed to the specific requirements of these regulations.