

Features

- Safeguard® slip-resistant surface provides excellent traction underfoot
- Single threshold for alcove installation with three tile-in flanges
- Right offset drain for easy 60" x 30" bath replacement
- Ideal size for remodel installations into a 60" (1524 mm) alcove with a shower door
- Rim size optimized for water containment and aesthetics
- Optional recessed drain sold separately

Material

- KOHLER® enameled cast iron

Required Products/Accessories

K-9155 Drain Cover

or

K-9156 Drain Cover

Recommended Products/Accessories

K-706009-D3 Frameless Sliding Shower Door

K-706009-L Frameless Sliding Shower Door

K-706015-D3 Frameless Sliding Shower Door

K-706015-L 74" H sliding shower door with 1/4"-thick glass

K-9132 Shower Drain

K-23726 Drain treatment

K-23725 Cast iron cleaner



Codes/Standards

ASME A112.19.1/CSA B45.2

ASTM F462

IAPMO Certification



KOHLER® Enameled Cast Iron Bath and Shower Base Lifetime Limited Warranty

See website for detailed warranty information.

Available Colors/Finishes

Color tiles intended for reference only.

Color	Code	Description
-------	------	-------------

	0	White
	96	Biscuit
	NY	Dune

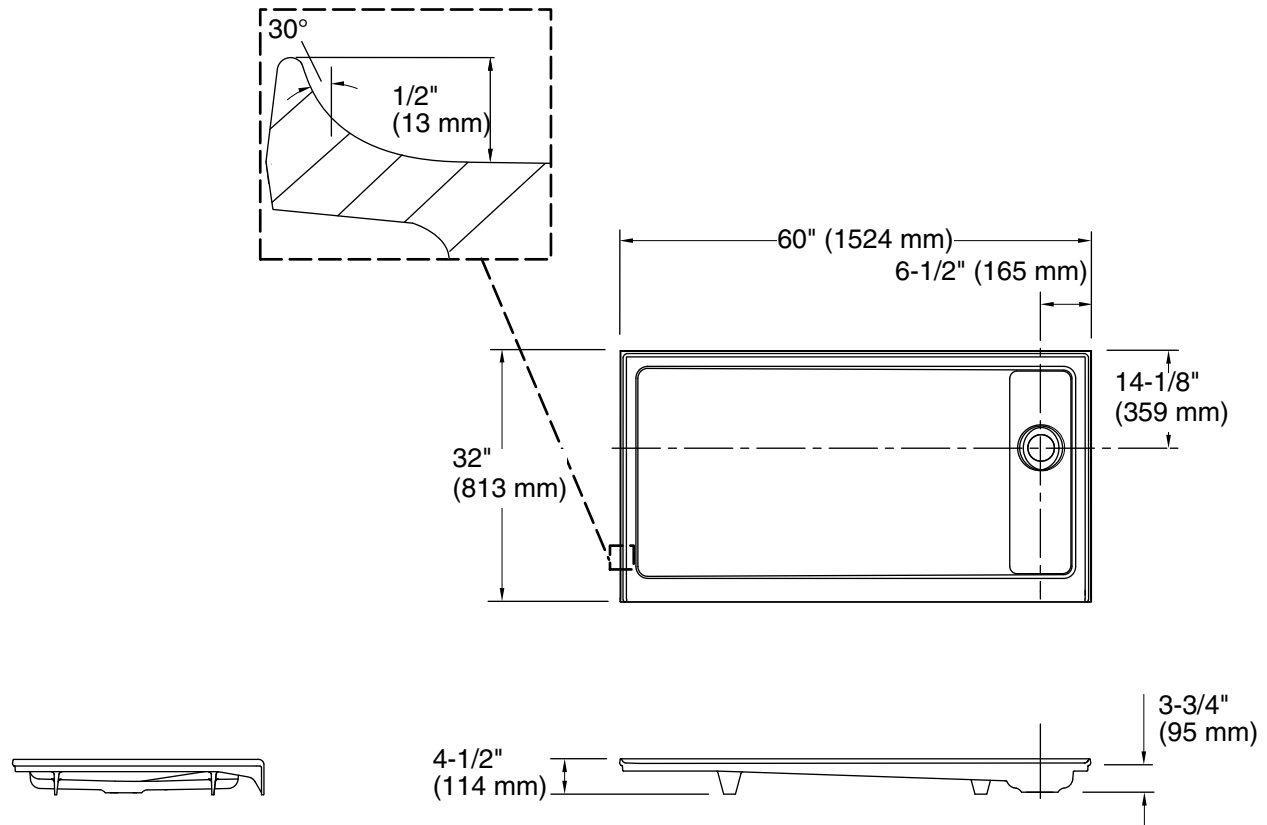

Technical Information

All product dimensions are nominal.

Drain location: Right
Weight: 180 lbs (81.6 kg)
Minimum flat for door: 2-7/16" (62 mm)

Notes

Measure your actual product for rough-in details.

Install this product according to the installation instructions.

The dimensions are applicable for this product only and should not be used to fabricate substitute bases for shower enclosures.

KOHLER steam generator/control kit is designed for use with this product. Kohler Co. shall not be responsible for problems encountered due to the installation and use of other manufacturer's steam generators.