

Features

- Integral lumbar support
- Slotted overflow allows for deep soaking
- Integral apron creates a clean, finished look
- Integral flange helps prevent water from seeping behind wall and simplifies alcove installation
- Textured bottom surface

Material

- Acrylic

Installation

- Left drain
- Requires K-7271 or K-7272 Clearflo slotted overflow bath drain (sold separately)
- Alcove

Required Products/Accessories

K-7271 Brass Slotted Overflow Bath Drain
K-7272 PVC Slotted Overflow Bath Drain

Recommended Products/Accessories

K-23726 Drain treatment
K-23732 Tub & shower cleaner
K-31797 Slotted overflow bath drain kit
K-31795 Slotted overflow above-the-floor bath drain kit



Codes/Standards







CSA B45.5/IAPMO Z124
ASTM E162
ASTM E662
IAPMO Certification

KOHLER® Plastic Baths and Receptors Lifetime Limited Warranty

See website for detailed warranty information.

Available Colors/Finishes

Color tiles intended for reference only.

Color	Code	Description
	0	White
	96	Biscuit
	NY	Dune
	95	Ice™ Grey
	58	Thunder™ Grey
	7	Black Black™

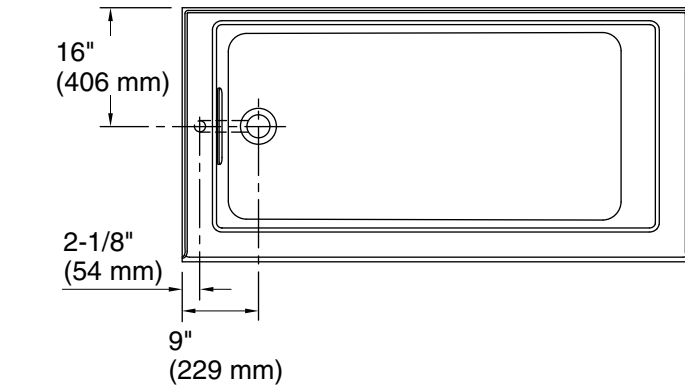

No change in measurements if connected with drain illustrated. (K-7272)

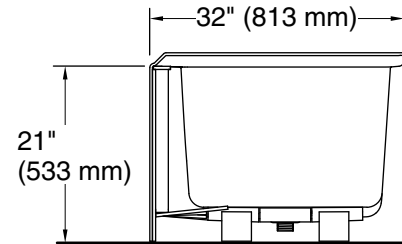
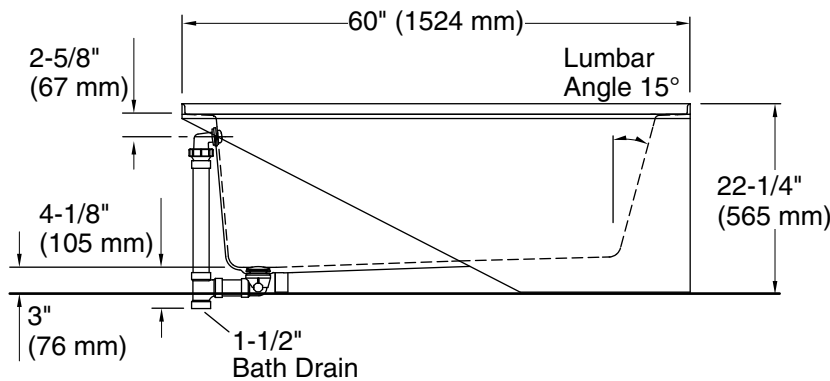
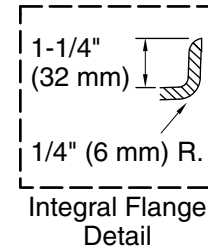

Technical Information

All product dimensions are nominal.

Drain location:	Left
Basin area, bottom:	46-1/4" x 22" (1175 mm x 559 mm)
Basin area, top:	52" x 24" (1321 mm x 610 mm)
Weight:	105 lbs (47.6 kg)
Minimum floor load:	56 lbs/ft ² (273.4 kg/m ²)
Water depth:	15-1/2" (394 mm)
Water capacity:	68 gal (257.4 L)
Minimum flat for door:	2-13/16" (72 mm)

Notes

Measure your actual product for rough-in details.

Install this product according to the installation instructions.

The hot water supply should be 70% of the capacity of the bath or greater. Installations will vary.