

Features

- Fast-Response® technology produces a luxurious steam shower in 60 seconds
- Power Clean™ technology offers one-touch automatic cleaning and safe maintenance
- Constant Steam produces steam at a consistent rate, which greatly minimizes temperature fluctuations
- The Invigoration Series uses approximately one gallon of water per 20-minute session, which is significantly less water than a traditional shower experience
- To ensure safety, the system automatically shuts down after 20 minutes if not reactivated by the user
- Requires K-5558 Invigoration Tandem Steam Generator Control Kit or K-5549-K1 DTV+ Tandem Steam Adapter Kit (sold separately)

Material

- Generators are constructed of insulated stainless steel, which maintains the temperature while ensuring the case is safe to the touch
- KOHLER® finishes resist corrosion and tarnishing

Installation

- 894 cubic feet maximum volume rating for custom showering applications

Required Products/Accessories

K-5558 Tandem steam generator control kit

or

K-5549-K1 Tandem Digital Steam Adapter Kit

Recommended Products/Accessories

K-5562 Large Drain Pan (Qty 2)



Codes/Standards

UL 499

CSA C22.2 No. 64

cUL Listed

KOHLER® Steam Generator Three-Year Limited Warranty

See website for detailed warranty information.

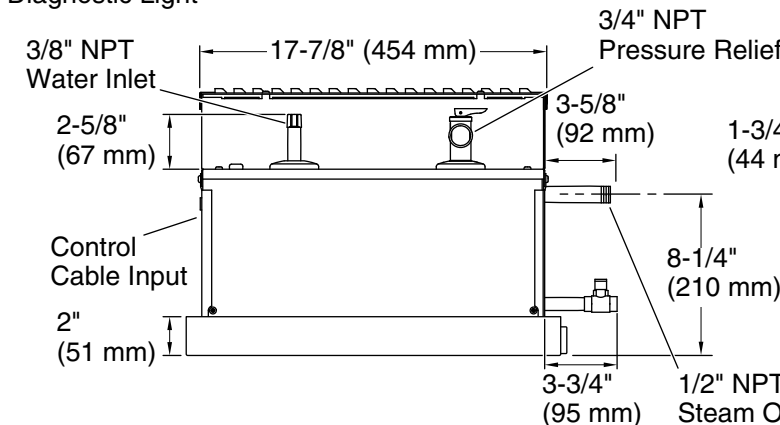
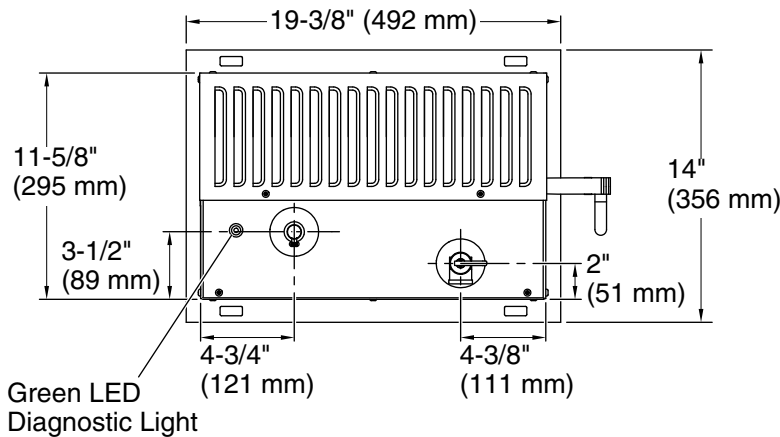

Minimum required access panel is 24" (610 mm) L x 15" (381 mm) H.

Allow for a minimum of 12" (305 mm) of space around all sides of the steam generator.

Allow for the drain/spill pan.

KOHLER® drain pan (shown) sold separately.

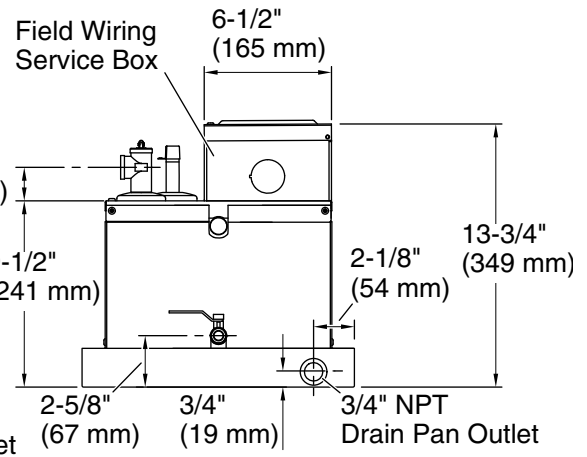

Required Electrical Service

Two dedicated non-GFCI circuits required.

Steam Generator: 240 V, 80 A, 60 Hz

Steam Generator: 240 V, 80 A, 60 Hz

Technical Information

All product dimensions are nominal.

Power source: Hardwire - AC, not included
Hardwire - AC, not included

Electrical component rating: Steam Generator: 240 V, 60 Hz, 13000 W

Steam Generator: 240 V, 60 Hz, 13000 W

Max. Ambient temp: 104°F (40°C)

Max. Relative humidity non-condensing: 95%

Max Inlet Pressure: 70 psi (482.6 kPa)

Recommended Feed Water Quality:

Water hardness: 60 ppm (3.5 gpg)

Total water 150 ppm (8.8 gpg)

1-800-4KOHLER (1-800-456-4537)

Kohler Co. reserves the right to make revisions without notice to product specifications.

For the most current Specification Sheet, go to www.kohler.com USA or www.kohler.ca Canada

2-10-2024 19:22 - US

Notes

Install this product according to the installation guide.

Steam room volume for this generator is 894 cubic feet (25.3 cubic meters).

For every foot of ceiling height over 8 ft (2.4 m), use the next larger steam unit.

For optimum performance, the steam generator must be installed within 25 ft (7.62 m) of the steam head.

Recommended feed water quality should be:
Hardness: 60 ppm (3.4 gpg). Total Alkalinity: 150 ppm (8.8 gpg). To ensure proper operation, the feed water supply should be tested prior to operating the steam generator. If feed water quality is not within the specified limit, contact a reputable water treatment company for treatment options.

Maximum inlet pressure is not to exceed 70 psi (483 kPa).

To ensure proper operation, the feed water