

### Features

- Frameless design emphasizes glass and creates a sleek, minimalist look
- Full-length magnetic seal keeps door firmly closed, providing excellent water containment
- Continuous 7/8" (22 mm) high aluminum bottom threshold
- Back-to-back 11-3/16" (284 mm) vertical shower door pulls
- Coordinates with other products in the Components collection
- CleanCoat®+ glass coating creates a hydrophobic barrier that repels water, soap scum, and residue, saving time and protecting shower doors 10 times longer than original CleanCoat. (Based on 2021 internal wear/abrasion testing using a microfiber cloth.)

### Material

- Frameless, 3/8" (10 mm) thick Crystal Clear tempered glass
- Anodized aluminum prevents rust and corrosion

### Installation

- Fits opening widths 39-5/8"–40-3/8" (1006–1026 mm)
- 3/4" (19 mm) width adjustment
- Out-of-plumb adjustability simplifies installation
- Door can be installed to open to the left or right to suit your bathroom layout
- For residential use only
- Not for use in hospitality

### Included Components

27710-10L 3/8" pivot door glass and hardware, no handle  
K-27679 11" shower door handle



### Codes/Standards

ANSI Z97.1  
CAN/CGSB-12.1  
CPSC 16CFR 1201

### KOHLER® Bath and Shower Doors Ten-Year Limited Warranty

See website for detailed warranty information.

### Available Colors/Finishes

*Color tiles intended for reference only.*

Color	Code	Description
	SHP	Bright Polished Silver
	BL	Matte Black
	BNK	Anodized Brushed Nickel

### Available Glass Options

Code	Description
L	Crystal Clear

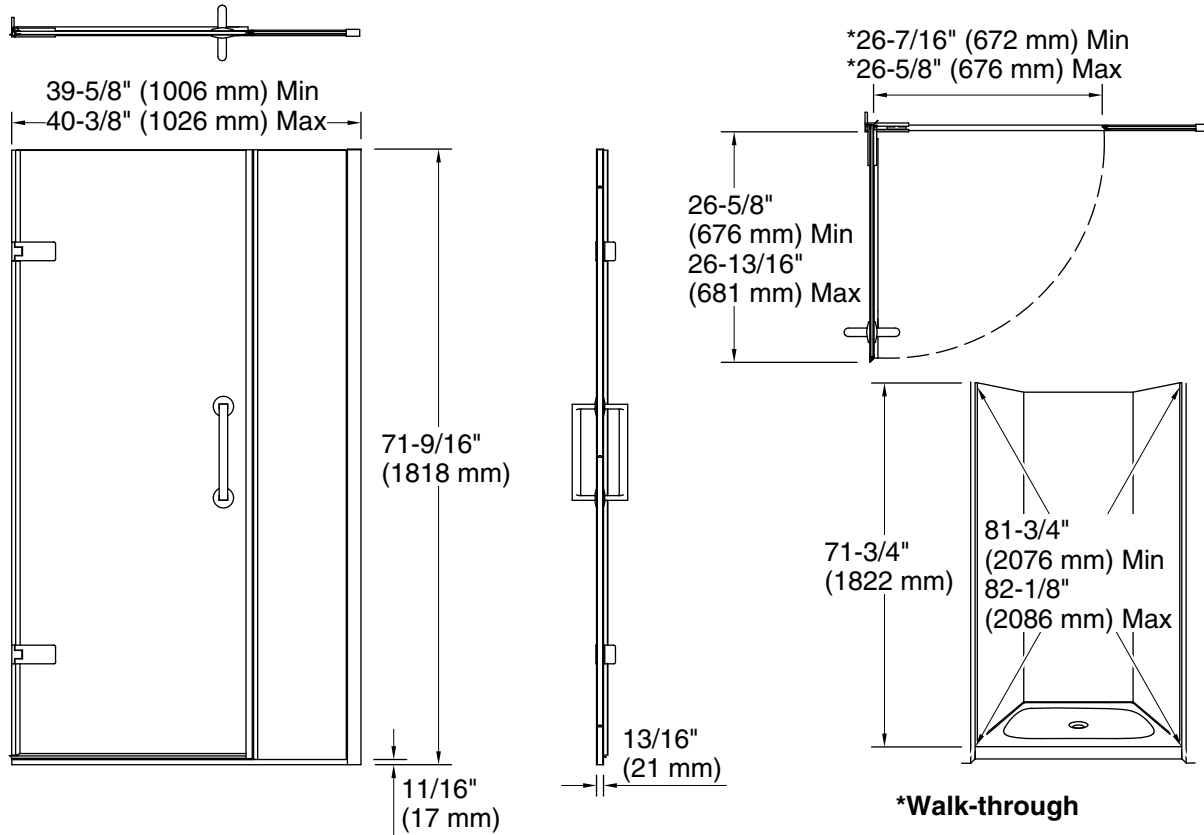

### Technical Information

All product dimensions are nominal.

Base-To-Wall 1/4" (6 mm)

Radius – Max:

### Notes

Install this product according to the installation instructions.

The vertical opening should be a minimum of 73-1/2" (1867 mm) to allow for installation clearance.