

Features

- Two lever handles offer separate control of hot and cold water
- Part of the Occasion bathroom faucet and accessory collection
- UltraGlide® valves with dry-stem technology are designed to eliminate common leak paths and provide smooth, effortless control

Material

- Premium metal construction for durability and reliability
- KOHLER® finishes resist corrosion and tarnishing

Installation

- For 8" – 16" (203 – 406 mm) centers
- Deck-mount
- Handles are preassembled on valves to simplify installation

Required Products/Accessories

For above-counter installation

- K-27008 Bathroom sink faucet spout with Cane design, 1.2 gpm
- K-27008-K Bathroom sink faucet spout with Cane design, 1.0 gpm
- K-27008-N Bathroom sink faucet spout with Cane design, 0.5 gpm
- K-27009 Bathroom sink faucet spout with Straight design, 1.2 gpm
- K-27009-K Bathroom sink faucet spout with Straight design, 1.0 gpm
- K-27009-N Bathroom sink faucet spout with Straight design, 0.5 gpm

Recommended Products/Accessories

- K-77967 Bathroom sink faucet spout with Tube design, 1.2 gpm
- K-77965 Bathroom sink faucet spout with Tube design, 1.2 gpm
- K-77968 Bathroom sink faucet spout with Ribbon design, 1.2 gpm
- K-77966 Bathroom sink faucet spout with Ribbon design, 1.2 gpm
- K-77969 Bathroom sink faucet spout with Row design, 1.2 gpm
- K-23887 Bathroom sink faucet spout with Row design, 1.2 gpm
- K-23723 Faucet cleaner
- K-27060 18" towel bar
- K-27061 24" towel bar
- K-27062 24" double towel bar



ADA

CSA B651

OBC

Codes/Standards







ASME A112.18.1/CSA B125.1
 NSF/ANSI/CAN 61
 NSF/ANSI/CAN 372
 All applicable US Federal and State material regulations
 ADA
 ICC/ANSI A117.1
 CSA B651
 OBC
 IAPMO Certification

KOHLER® Faucet Lifetime Limited Warranty

See website for detailed warranty information.

Available Colors/Finishes

Color tiles intended for reference only.

| Color | Code | Description |
|---|------|--------------------------------|
|  | CP | Polished Chrome |
|  | SN | Vibrant® Polished Nickel |
|  | BN | Vibrant® Brushed Nickel |
|  | BL | Matte Black |
|  | 2MB | Vibrant® Brushed Moderne Brass |
|  | BMB | Matte Black with Moderne Brass |

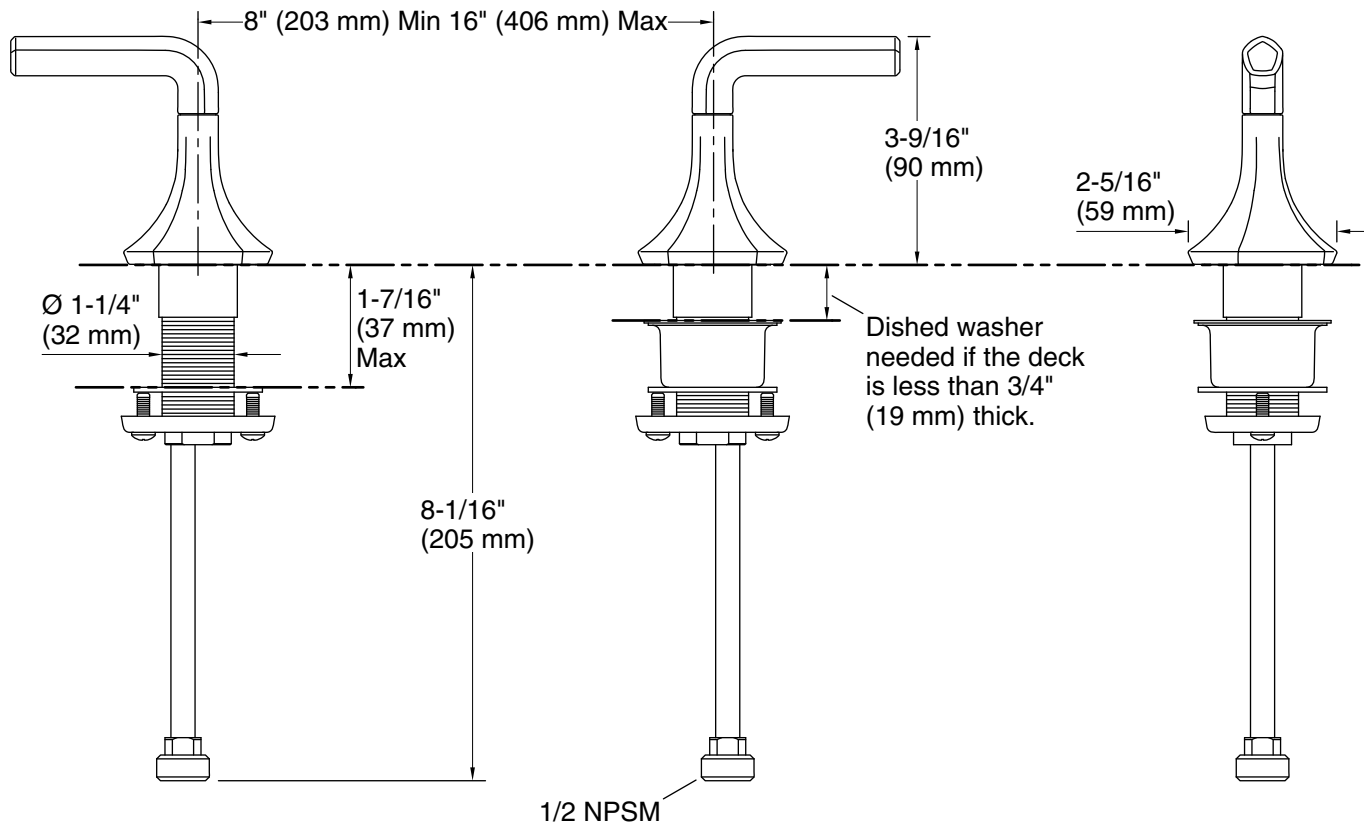

Technical Information

All product dimensions are nominal.

Faucet:

Flow rate: 1.2 gal/min (4.5 l/min)

Pressure: 60 psi (4.1 bar)

Drain included: No

Drain with overflow: Yes

Notes

Install this product according to the installation instructions.

ADA, OBC, CSA B651 compliant when installed to the specific requirements of these regulations.