

# KOHLER® Faucets Deck-mount bath faucet handle trim with Lever design **Artifacts®** K-T98071-4

## Features

- Lever handle style option
- Metal construction

## Installation

- Bath- or deck-mount

## Recommended Products/Accessories

- K-23723 Faucet cleaner
- K-72567 18" Towel Bar
- K-72568 24" Towel Bar
- K-72570 24" Double Towel Bar
- K-72571 Towel Ring
- K-72572 Robe Hook
- K-72573 Pivoting toilet paper holder
- K-72576 Toilet paper carriage



**ADA** **CSA B651** **OBC**

## Codes/Standards







ASME A112.18.1/CSA B125.1  
ADA  
ICC/ANSI A117.1  
CSA B651  
OBC  
IAPMO Certification

## KOHLER® Faucet Lifetime Limited Warranty

See website for detailed warranty information.

## Available Colors/Finishes

*Color tiles intended for reference only.*

Color	Code	Description
	CP	Polished Chrome
	SN	Vibrant® Polished Nickel
	BN	Vibrant® Brushed Nickel
	BV	Vibrant® Brushed Bronze
	2BZ	Oil-Rubbed Bronze
	2MB	Vibrant® Brushed Moderne Brass

1-800-4KOHLER (1-800-456-4537)

Kohler Co. reserves the right to make revisions without notice to product specifications.

For the most current Specification Sheet, go to [www.kohler.com](http://www.kohler.com).USA

1-13-2024 20:37 - US

THE BOLD LOOK  
OF **KOHLER®**

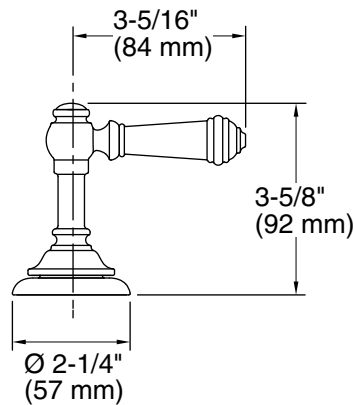
**Technical Information**

All product dimensions are nominal.

Drain included: No

**Notes**

Install this product according to the installation instructions.

**IMPORTANT!** Artifacts deck-mount handles are only compatible with the valve included with the Artifacts deck-mount faucets. Do not install to a K-300 bath valve.

ADA, OBC, CSA B651 compliant when installed to the specific requirements of these regulations.