

Features

- 9" (229 mm) spout reach
- 3" (76 mm) high nondiverter spout
- Variety of handle style options (sold separately)
- Nondiverter spout
- 15 gpm (gallons per minute) bath faucet flow rate
- KOHLER® ceramic disc valves exceed industry longevity standards for a lifetime of durable performance
- Coordinates with other products in the Artifacts collection
- Handle trim sold separately

Material

- Brass
- KOHLER® finishes resist corrosion and tarnishing

Installation

- Finished deck-mount installation only

Required Products/Accessories

K-T98071-4 Deck-mount bath faucet handle trim with Lever design

Recommended Products/Accessories

K-23723 Faucet cleaner
K-72567 18" Towel Bar
K-72568 24" Towel Bar
K-72570 24" Double Towel Bar
K-72571 Towel Ring
K-72572 Robe Hook
K-72573 Pivoting toilet paper holder
K-72576 Toilet paper carriage

Included Components

1354692 1/2" recessed deck-mount bath valve kit



Codes/Standards







ASME A112.18.1/CSA B125.1
IAPMO Certification

KOHLER® Faucet Lifetime Limited Warranty

See website for detailed warranty information.

Available Colors/Finishes

Color tiles intended for reference only.

Color	Code	Description
	CP	Polished Chrome
	SN	Vibrant® Polished Nickel
	BN	Vibrant® Brushed Nickel
	BV	Vibrant® Brushed Bronze
	2BZ	Oil-Rubbed Bronze
	2MB	Vibrant® Brushed Moderne Brass

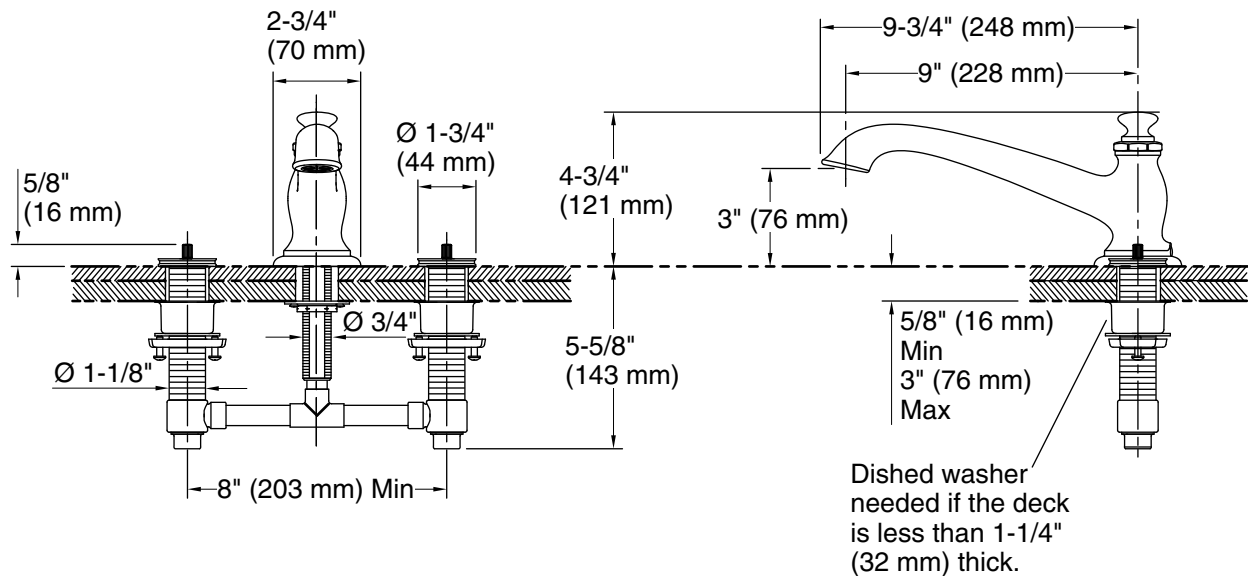

Technical Information

All product dimensions are nominal.

Drain included: No

Spout:

Spout reach: 9" (229 mm)

Notes

IMPORTANT! Artifacts deck-mount handles are only compatible with the valve included with the Artifacts deck-mount faucets. Do not install to a K-300 bath valve.

IMPORTANT! For K-T98071-9M models, the handle swings up and toward the user. Ensure that the handle will not interfere with the bath fixture during operation.

Install this product according to the installation guide.

For a finished bath deck/rim less than 5/8" (16 mm) thick: Install wood reinforcing material to the underside of the deck/rim. The combined thickness of the reinforcing material and the deck/rim must not exceed 3" (76 mm).