

## Features

- 36" minimum base cabinet width
- Single bowl
- 9-1/2" (241 mm) depth provides generous workspace
- Offset drain increases workspace in the sink and storage space underneath
- Includes K-5196 sink rack
- Includes cutout templates and installation clips
- Matte finish offers rich, dimensional color

## Material

- KOHLER Neoroc® composite is durable and built to withstand day-to-day cleaning tasks
- Solid color throughout the sink
- Heat-resistant up to 750°F
- Scratch-, stain-, chip-, and thermal-shock-resistant

## Installation

- Undermount
- Easy to install in a one-person, single-day project

## Required Products/Accessories

K-5192 Small stainless steel sink rack for K-8206

or

K-11352 Disposal Flange with Stopper

or

K-8801 Sink drain and strainer with tailpiece

or

K-8799 Sink drain and strainer basket

## Recommended Products/Accessories

K-23730 Neoroc® cleaner

K-23726 Drain treatment

## Optional Products/Accessories

K-9000 P-Trap

## Included Components

K-5196 Sink Rack



## Codes/Standards







CSA B45.5/IAPMO Z124

## KOHLER® Neoroc® Sinks Lifetime Limited Warranty

See website for detailed warranty information.

## Available Colors/Finishes

*Color tiles intended for reference only.*

Color	Code	Description
	CM6	Matte White
	CM7	Matte Graphite
	CM1	Matte Black
	CM2	Matte Brown
	CM3	Matte Taupe
	CM4	Matte Grey

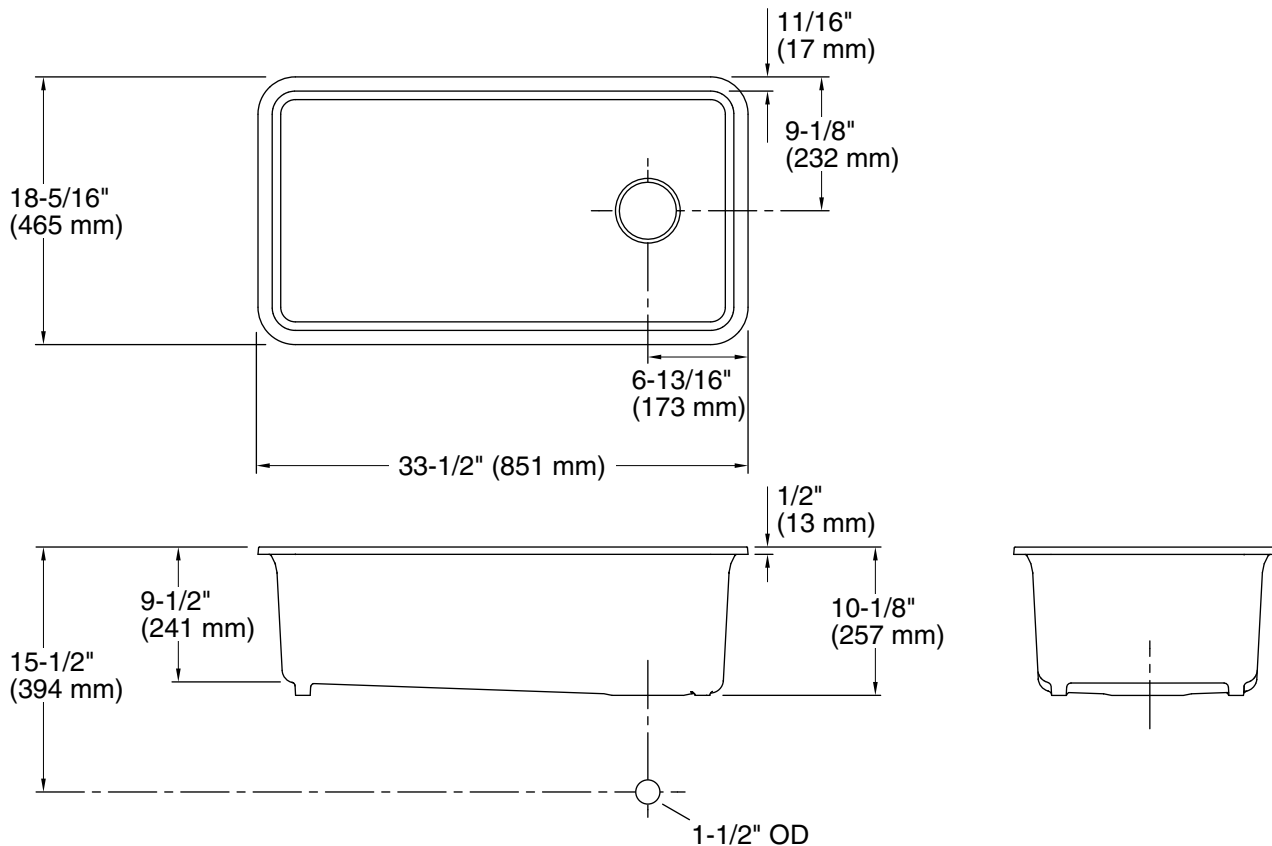

#### Technical Information

All product dimensions are nominal.

Bowl configuration: Single

Min. base cabinet width: 36" (914 mm)

Bowl area (Only):  
 Length: 30-9/16" (777 mm)  
 Width: 15-3/8" (391 mm)  
 Bowl depth: 9-1/2" (241 mm)  
 Water depth: 9-1/2" (241 mm)

Drain hole: 3-7/8" (98 mm)

Template: 1256394-7, required, included

#### Notes

Install this product according to the installation instructions.

Allow a minimum of 2" (51 mm) clearance around the sink rim for clip attachment.