

Features

- 36" minimum base cabinet width
- Large/medium bowls
- Versatile design allows large bowl to be installed on the right or left
- Large basin is 9-1/2" deep (241 mm); small basin is 7-1/2" (191 mm) deep
- Slim divide creates more space while allowing you to completely submerge pots and pans
- Offset drain increases workspace in the sink
- Includes K-5655 sink rack
- Includes cutout templates and installation clips
- Matte finish offers rich, dimensional color

Material

- KOHLER Neoroc® composite is durable and built to withstand day-to-day cleaning tasks
- Solid color throughout the sink
- Heat-resistant up to 750°F
- Scratch-, stain-, chip-, and thermal-shock-resistant

Installation

- Undermount
- Easy to install in a one-person, single-day project

Recommended Products/Accessories

- K-5198 Sink Rack
- K-8801 Sink drain and strainer with tailpiece
- K-8799 Sink drain and strainer basket
- K-23726 Drain treatment
- K-23730 Neoroc® cleaner

Optional Products/Accessories

- K-11352 Disposal Flange with Stopper
- K-9000 P-Trap

Included Components

- K-5655 Sink Rack



Codes/Standards







CSA B45.5/IAPMO Z124

KOHLER® Neoroc® Sinks Lifetime Limited Warranty

See website for detailed warranty information.

Available Colors/Finishes

Color tiles intended for reference only.

Color	Code	Description
	CM6	Matte White
	CM7	Matte Graphite
	CM1	Matte Black
	CM2	Matte Brown
	CM3	Matte Taupe
	CM4	Matte Grey

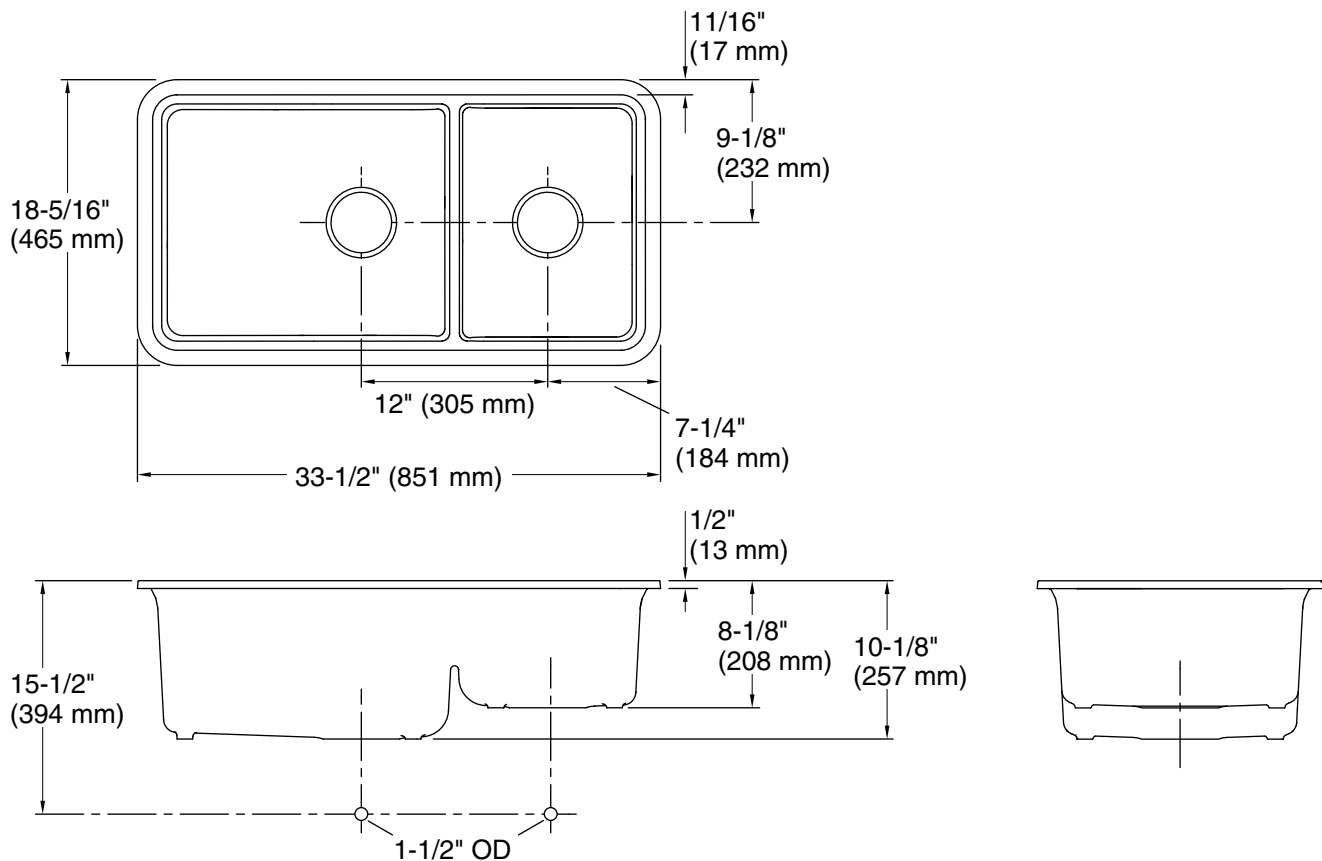

Technical Information

All product dimensions are nominal.

Bowl configuration: Off-set Large/small

Min. base cabinet width: 36" (914 mm)

Bowl area (Left):
 Length: 18-7/16" (468 mm)
 Width: 15-3/16" (386 mm)
 Bowl depth: 9-1/2" (241 mm)
 Water depth: 9-1/2" (241 mm)

Bowl area (Right):
 Length: 11-5/16" (288 mm)
 Width: 15-3/16" (386 mm)
 Bowl depth: 7-1/2" (191 mm)
 Water depth: 7-1/2" (191 mm)

Drain hole: 3-7/8" (98 mm)

Template: 1256394-7, required, included

Notes

Install this product according to the installation instructions.