

## Features

- 36" minimum base cabinet width
- Double-equal bowls
- 9-1/2" (241 mm) depth provides generous workspace
- Slim divide creates more space while allowing you to completely submerge pots and pans
- Rear drains increase workspace in the sink and storage space underneath
- Includes K-5656 sink rack
- Includes cutout templates and installation clips
- Matte finish offers rich, dimensional color

## Material

- KOHLER Neoroc® composite is durable and built to withstand day-to-day cleaning tasks
- Solid color throughout the sink
- Heat-resistant up to 750°F
- Scratch-, stain-, chip-, and thermal-shock-resistant

## Installation

- Undermount
- Easy to install in a one-person, single-day project

## Recommended Products/Accessories

- K-5656 Sink Rack
- K-8801 Sink drain and strainer with tailpiece
- K-8799 Sink drain and strainer basket
- K-23726 Drain treatment
- K-23730 Neoroc® cleaner

## Optional Products/Accessories

- K-11352 Disposal Flange with Stopper
- K-9000 P-Trap

## Included Components

- K-5656 Sink Rack



## Codes/Standards







CSA B45.5/IAPMO Z124

## KOHLER® Neoroc® Sinks Lifetime Limited Warranty

See website for detailed warranty information.

## Available Colors/Finishes

*Color tiles intended for reference only.*

Color	Code	Description
	CM6	Matte White
	CM7	Matte Graphite
	CM4	Matte Grey
	CM1	Matte Black
	CM2	Matte Brown
	CM3	Matte Taupe

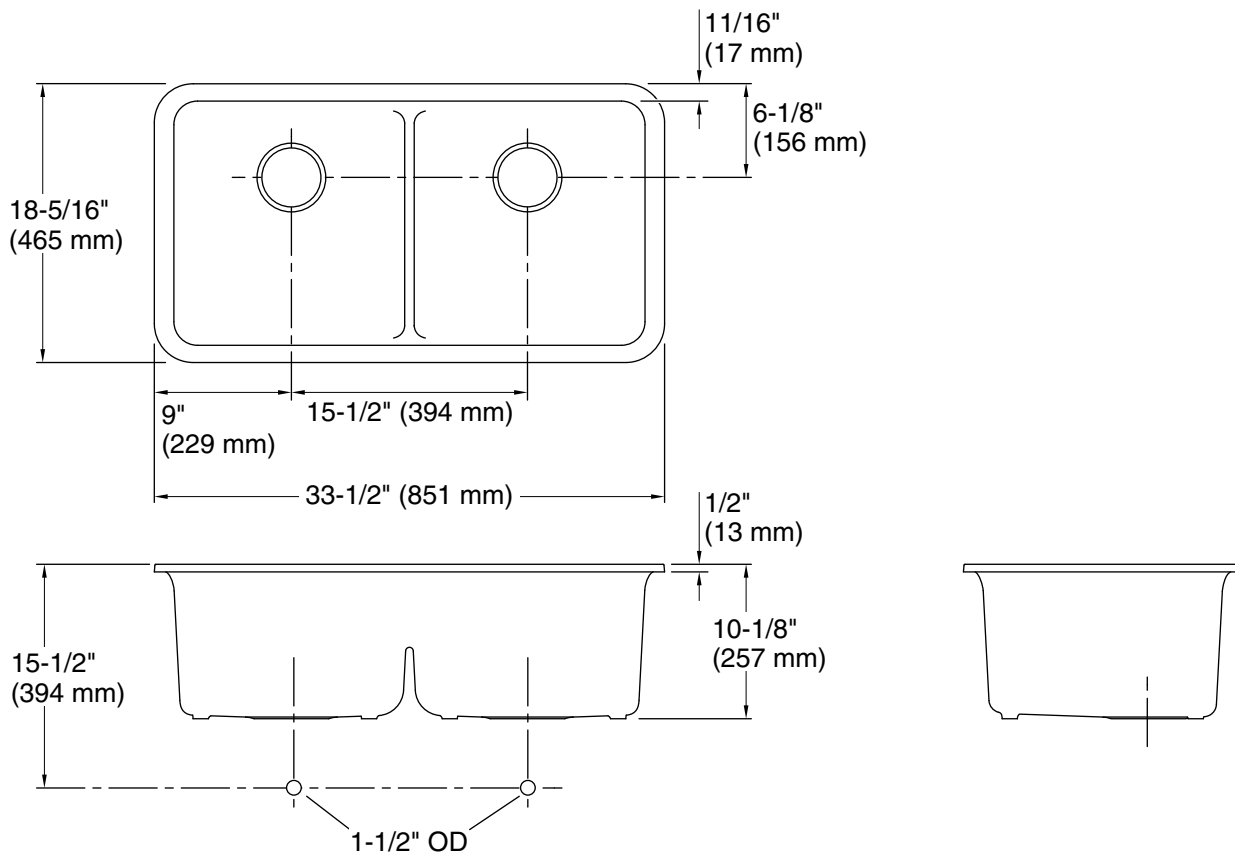

## Technical Information

All product dimensions are nominal.

Bowl configuration: Double equal

Min. base cabinet width: 36" (914 mm)

Bowl area (Left):  
Length: 14-7/8" (378 mm)  
Width: 15-3/16" (386 mm)  
Bowl depth: 9-1/2" (241 mm)  
Water depth: 9-1/2" (241 mm)

Bowl area (Right):  
Length: 14-7/8" (378 mm)  
Width: 15-3/16" (386 mm)  
Bowl depth: 9-1/2" (241 mm)  
Water depth: 9-1/2" (241 mm)

Drain hole: 3-7/8" (98 mm)

Template: 1256394-7, required, included

## Notes

Install this product according to the installation instructions.