



Whitehaven®
23-1/2" undermount single-bowl farmhouse kitchen
sink
K-5664

Features

- Fits minimum 24" (610 mm) base cabinet width
- Single bowl
- 9" (229 mm) depth provides generous workspace
- Shortened apron allows sink to be used in most standard cabinetry or retrofitted to existing standard cabinetry
- Self-Trimming® apron overlaps cabinet face for easy installation and beautiful results

Material

- KOHLER® enameled cast iron

Installation

- Center drain
- Cutout templates included
- Undermount

Recommended Products/Accessories

- K-8395 Sink Rack
- K-8801 Sink drain and strainer with tailpiece
- K-8799 Sink drain and strainer basket
- K-23726 Drain treatment
- K-23725 Cast iron cleaner

Optional Products/Accessories

- K-11352 Disposal Flange with Stopper
- K-9000 P-Trap



Codes/Standards









ASME A112.19.1/CSA B45.2

KOHLER® Enameled Cast Iron Kitchen and Bathroom Sink Lifetime Limited Warranty

See website for detailed warranty information.

Available Colors/Finishes

Color tiles intended for reference only.

Color	Code	Description
	0	White
	FF	Sea Salt™
	96	Biscuit
	NY	Dune
	95	Ice™ Grey
	58	Thunder™ Grey
	7	Black Black™
	TRF	Truffle

1-800-4KOHLER (1-800-456-4537)

Kohler Co. reserves the right to make revisions without notice to product specifications.

For the most current Specification Sheet, go to www.kohler.com.

12-1-2023 22:09 - US/CA

THE BOLD LOOK
OF **KOHLER®**

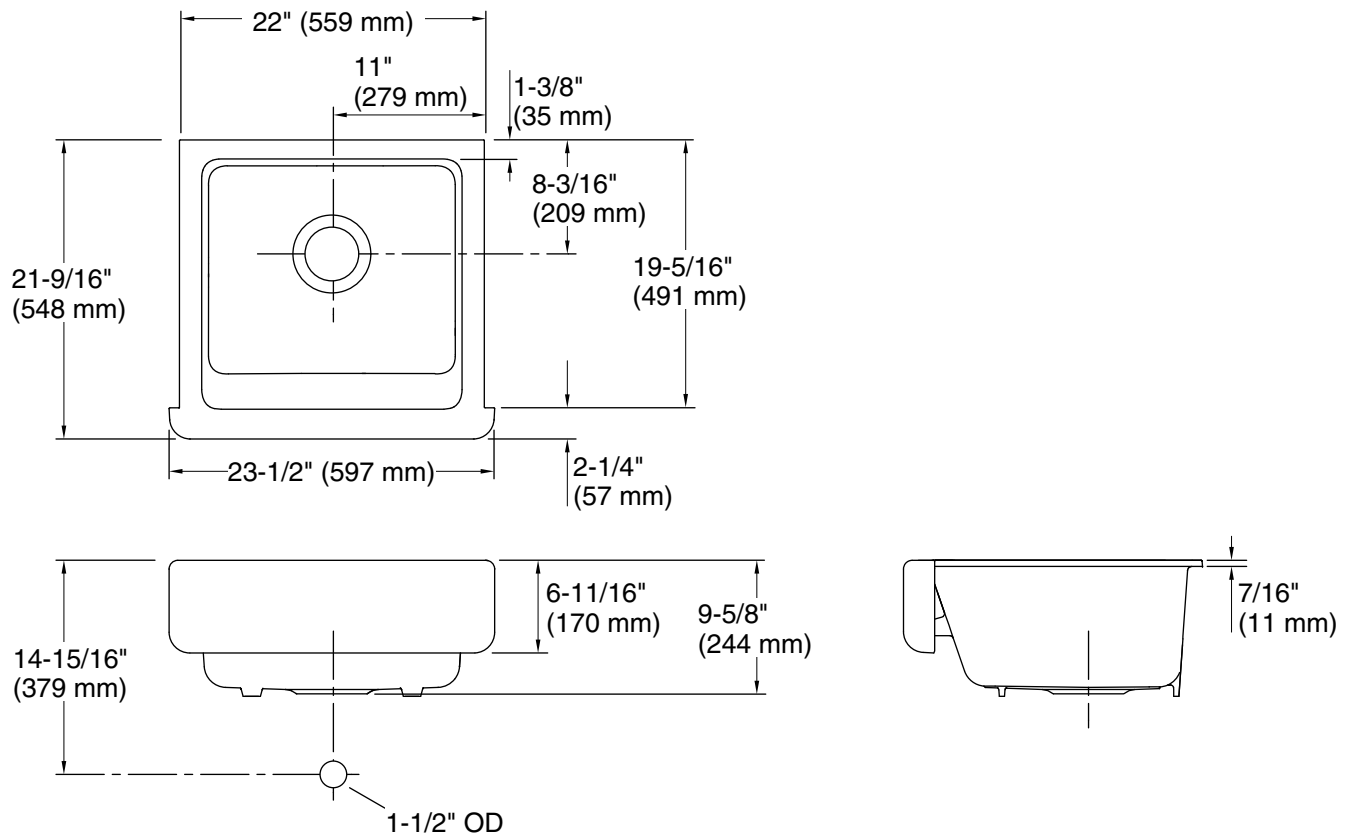

Technical Information

All product dimensions are nominal.

Bowl configuration: Single

Min. base cabinet width: 24" (610 mm)

Bowl area (Only):
 Length: 18-13/16" (477 mm)
 Width: 18-1/16" (459 mm)
 Bowl depth: 9" (229 mm)
 Water depth: 9" (229 mm)

Drain hole: 3-5/8" (92 mm)

Template: 1247776-7, required, included
 1239229-7, required, included

Notes

Install this product according to the installation instructions.

NOTICE: Countertop manufacturer or cutter must use the current product template available at www.kohler.com, or by calling 1-800-4KOHLER. Kohler Co. is not responsible for cutout errors when the incorrect cutout template is used.

IMPORTANT! The distance from the top edge of the cabinet to the top of the cabinet door must be at least 6-7/8" (175 mm) to install this sink.