

Features

- Fits minimum 36" (914 mm) apron sink base cabinet
- 9-1/2" (241 mm) depth provides generous workspace
- Matte finish offers rich, dimensional color
- Offset drain increases workspace in the sink and storage space underneath
- Self-Trimming® apron overlaps cabinet face for easy installation and beautiful results

Material

- KOHLER Neoroc® composite is durable and built to withstand day-to-day cleaning tasks
- Solid color throughout the sink
- Scratch-, stain-, chip-, and thermal-shock-resistant
- Heat-resistant up to 750°F

Installation

- Undermount

Required Products/Accessories

K-8801 Sink drain and strainer with tailpiece

or

K-8799 Sink drain and strainer basket

or

K-11352 Disposal Flange with Stopper

Optional Products/Accessories

K-9000 P-Trap

Included Components

K-26026 Farmhouse kitchen sink towel hook

K-30182 Sink racks



Codes/Standards







CSA B45.5/IAPMO Z124

KOHLER® Neoroc® Sinks Lifetime Limited Warranty

See website for detailed warranty information.

Available Colors/Finishes

Color tiles intended for reference only.

Color	Code	Description
	CM6	Matte White
	CM7	Matte Graphite
	CM1	Matte Black
	CM2	Matte Brown
	CM3	Matte Taupe
	CM4	Matte Grey

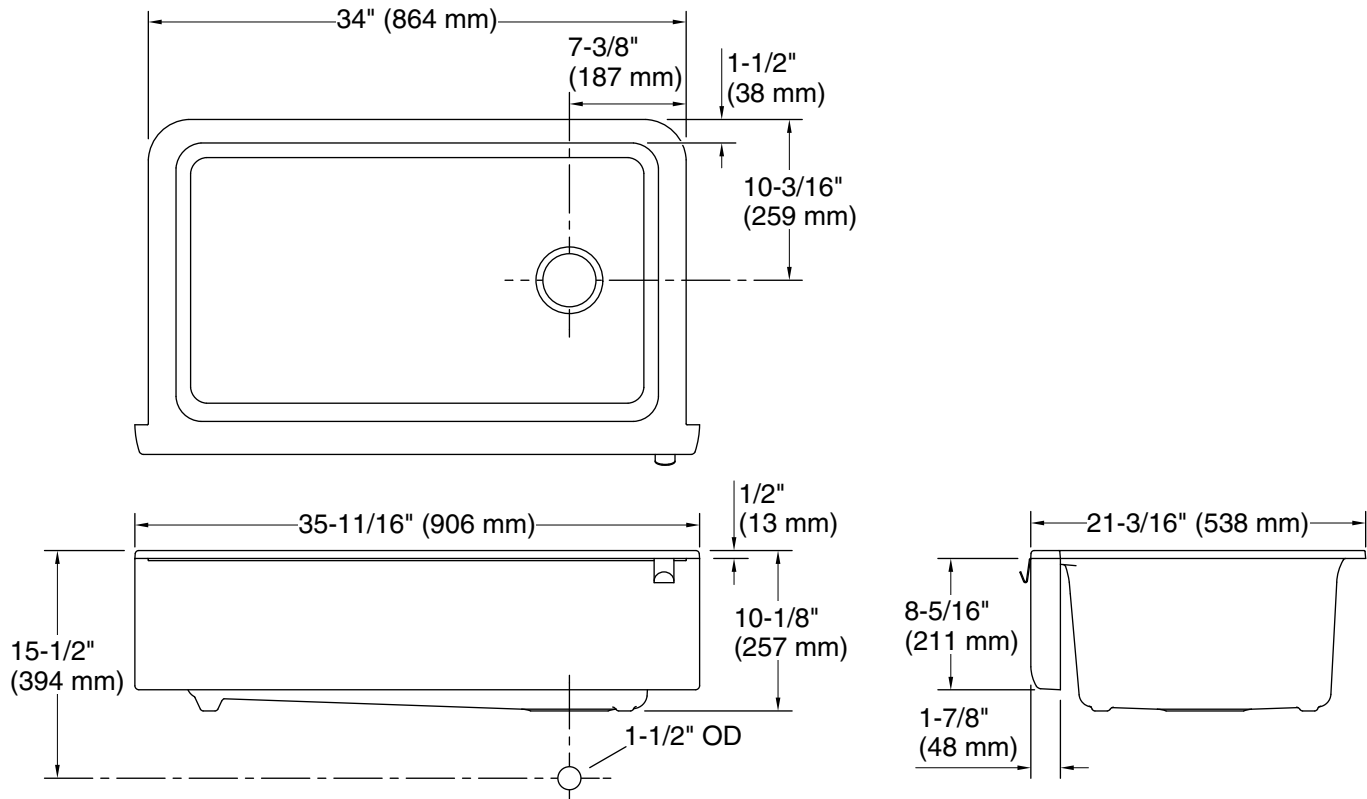

Technical Information

All product dimensions are nominal.

Bowl configuration: Single

Min. base cabinet width: 36" (914 mm)

Bowl area (Only):
 Length: 28-5/8" (726 mm)
 Width: 15-1/2" (394 mm)
 Bowl depth: 9-1/2" (241 mm)
 Water depth: 9-1/2" (241 mm)

Drain hole: 3-7/8" (98 mm)

Template: Apron-front, 1400299-7, required, included

Notes

Install this product according to the installation instructions.