

Features

- Fits minimum 36" apron sink base cabinet.
- 9-1/2"-deep single bowl.
- Shortened apron allows sink to be used in most standard cabinetry or retrofitted to existing standard cabinetry.
- Plain front design.
- Matte finish offers rich, dimensional color.
- Solid color throughout the sink.
- Scratch, stain, chip, and thermal-shock resistant.
- Offset drain increases workspace in the sink and storage space underneath.

Material

- KOHLER Neoroc® composite is durable and built to withstand day-to-day cleaning tasks.
- Heat resistant up to 750°F.

Installation

- Undermount.
- No faucet holes.
- Self-Trimming® apron overlaps the cabinet face for easy installation.

Included Components

- K-26026 Farmhouse kitchen sink towel hook
- K-30182 Sink racks



Codes/Standards







CSA B45.5/IAPMO Z124

KOHLER® Neoroc® Sinks Lifetime Limited Warranty

See website for detailed warranty information.

Available Colors/Finishes

Color tiles intended for reference only.

| Color | Code | Description |
|---|------|----------------|
|  | CM6 | Matte White |
|  | CM7 | Matte Graphite |
|  | CM1 | Matte Black |
|  | CM2 | Matte Brown |
|  | CM3 | Matte Taupe |
|  | CM4 | Matte Grey |

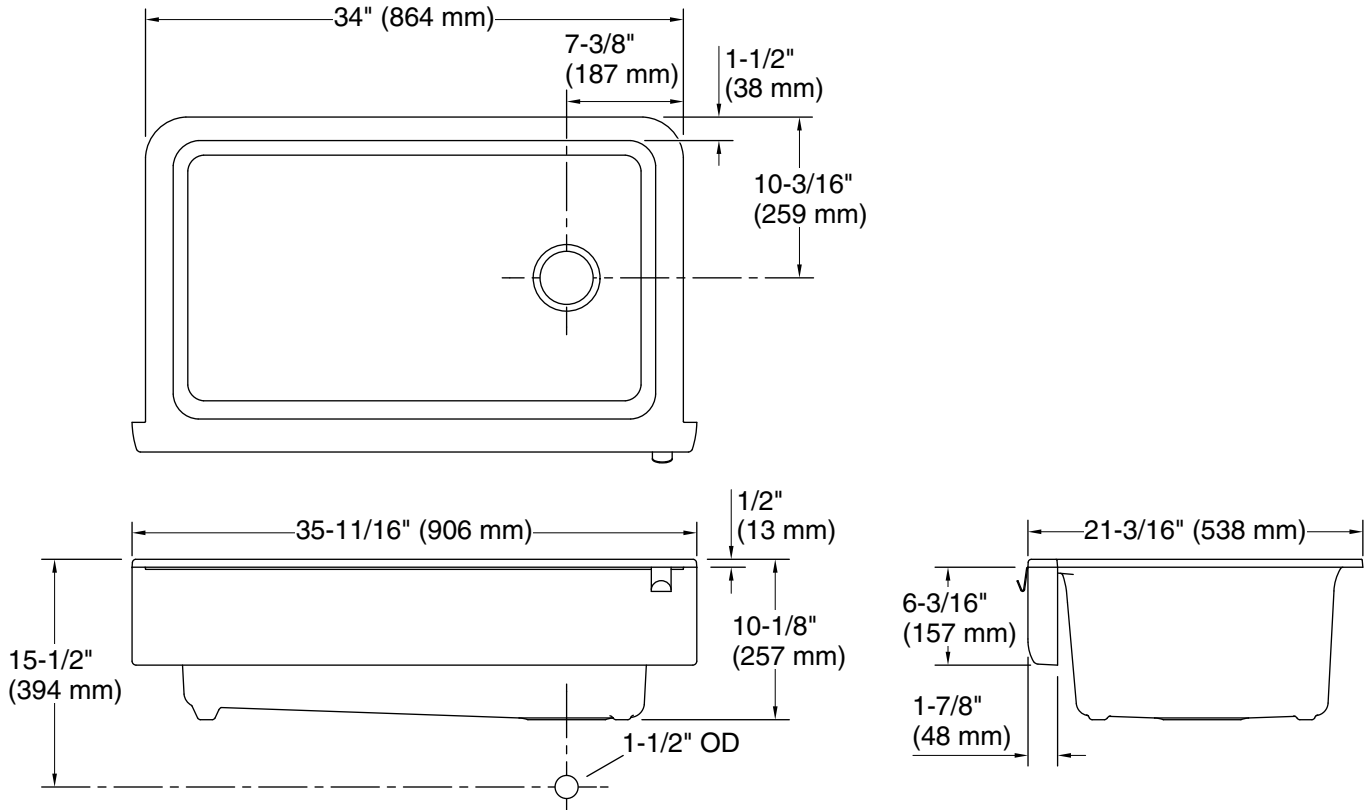

Technical Information

All product dimensions are nominal.

Bowl configuration: Single

Min. base cabinet width: 36" (914 mm)

Bowl area (Only):
 Length: 28-5/8" (726 mm)
 Width: 15-1/2" (394 mm)
 Bowl depth: 9-1/2" (241 mm)
 Water depth: 9-1/2" (241 mm)

Drain hole: 3-7/8" (98 mm)

Template: Apron-front, 1400299-7, required, included

Notes

Install this product according to the installation instructions.