



Iron/Tones®

33" top-/undermount single-bowl kitchen sink

K-5707

Features

- 33" (838 mm) minimum base cabinet width for top-mount installation
- 36" (914 mm) minimum base cabinet width for undermount installation
- Single bowl
- 9" (229 mm) depth provides generous workspace

Material

- KOHLER® enameled cast iron

Installation

- Top-mount or undermount

Recommended Products/Accessories

- K-8801 Sink drain and strainer with tailpiece
- K-8799 Sink drain and strainer basket
- K-23726 Drain treatment
- K-23725 Cast iron cleaner
- 1411886 Undermount sink kit 23"

Optional Products/Accessories

- K-8342 Sink rack for Iron/Tones® kitchen sink
- K-11352 Disposal Flange with Stopper
- K-9000 P-Trap



Codes/Standards









ASME A112.19.1/CSA B45.2

KOHLER® Enameled Cast Iron Kitchen and Bathroom Sink Lifetime Limited Warranty

See website for detailed warranty information.

Available Colors/Finishes

Color tiles intended for reference only.

Color	Code	Description
	0	White
	FF	Sea Salt™
	96	Biscuit
	NY	Dune
	95	Ice™ Grey
	58	Thunder™ Grey
	7	Black Black™
	TRF	Truffle
	DGB	Indigo Blue

1-800-4KOHLER (1-800-456-4537)

Kohler Co. reserves the right to make revisions without notice to product specifications.

For the most current Specification Sheet, go to www.kohler.com.

12-4-2023 21:19 - US/CA

THE BOLD LOOK
OF **KOHLER**®

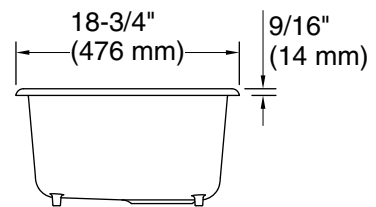
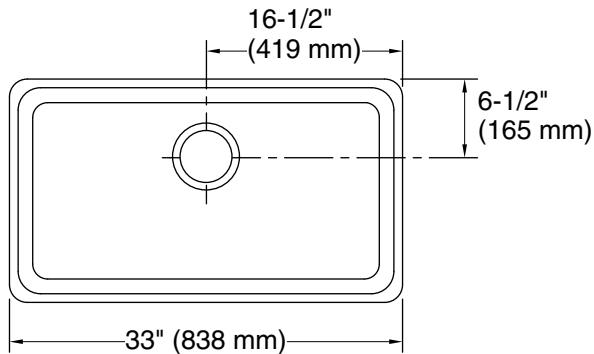

Technical Information

All product dimensions are nominal.

Min. base cabinet width: 36" (914 mm)

Bowl area (Only): Length: 30-5/16" (770 mm)
Width: 16-1/16" (408 mm)
Bowl depth: 9" (229 mm)
Water depth: 9" (229 mm)

Drain hole: 3-7/8" (98 mm)

Template: 1043168-7, required, included

Notes

Install this product according to the installation instructions.

Countertop manufacturer or cutter must use the cut-out template provided with the product, or a current one provided by Kohler Co. (call 1-800-43-FOCUS). Kohler Co. is not responsible for cut-out errors when the incorrect cut-out template is used.