



Northland™

15" undermount single-bowl bar sink

K-6589-U

Features

- 15" (381 mm) minimum base cabinet width
- Single bowl
- 7" depth

Material

- KOHLER® enameled cast iron

Installation

- Includes undermount installation kit for simplified installation
- Undermount

Recommended Products/Accessories

- K-8801 Sink drain and strainer with tailpiece
- K-8799 Sink drain and strainer basket
- K-23726 Drain treatment
- K-23725 Cast iron cleaner

Optional Products/Accessories

- K-11352 Disposal Flange with Stopper
- K-9000 P-Trap

Included Components

- 52047 Clamp Accessory Pack, 4 Ea.



ADA

Codes/Standards









ASME A112.19.1/CSA B45.2
ADA
ICC/ANSI A117.1

KOHLER® Enameled Cast Iron Kitchen and Bathroom Sink Lifetime Limited Warranty

See website for detailed warranty information.

Available Colors/Finishes

Color tiles intended for reference only.

Color	Code	Description
	0	White
	FF	Sea Salt™
	96	Biscuit
	NY	Dune
	95	Ice™ Grey
	58	Thunder™ Grey
	7	Black Black™
	TRF	Truffle

1-800-4KOHLER (1-800-456-4537)

Kohler Co. reserves the right to make revisions without notice to product specifications.

For the most current Specification Sheet, go to www.kohler.com.

11-10-2023 23:10 - US/CA/MX

THE BOLD LOOK
OF **KOHLER**®

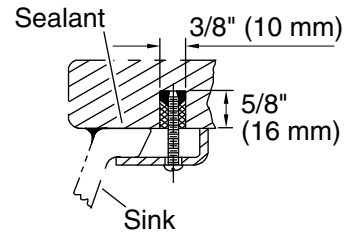
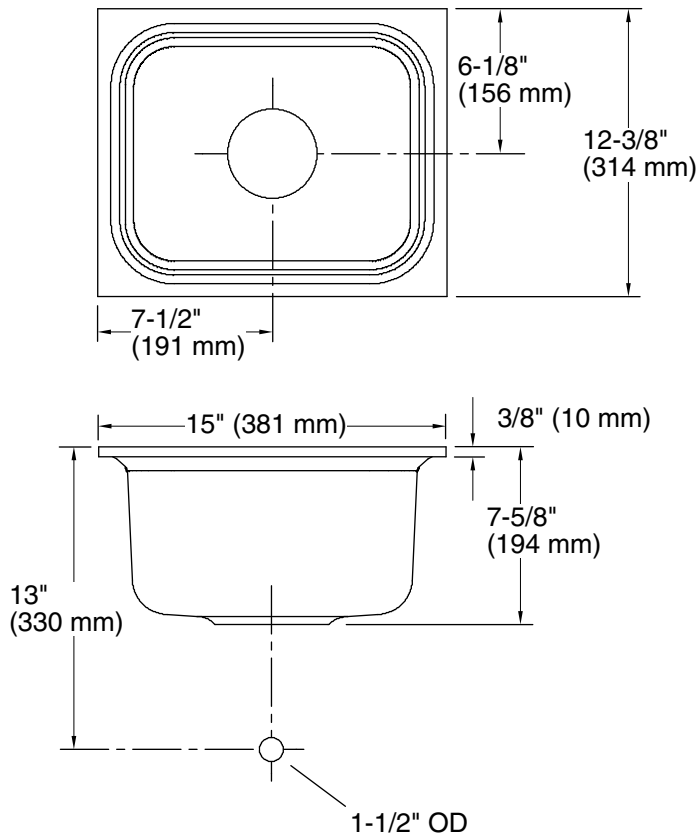

Marble Slab
Installation

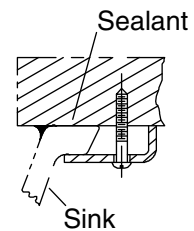
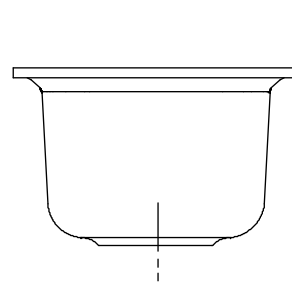

Wood Counter
Installation

Note: Waterproof the unprotected overhang area on the underside of a wood counter.

Technical Information

All product dimensions are nominal.

Bowl configuration:	Single
Min. base cabinet width:	15" (381 mm)
Bowl area:	Length: 12" (305 mm) Width: 9-1/4" (235 mm) Bowl depth: 7" (178 mm)
Drain hole:	3-7/8" (98 mm)
Template:	1086707-7, required, included

Notes

Install this product according to the installation instructions.

Supplied bowl clamp assemblies require 1" (25 mm) minimum countertop thickness. Installer must supply anchors for thinner countertops.

For multiple bowl under-mount installations, a minimum distance of 3-3/8" (86 mm) is required between bowls. Countertop supplier to determine required support.

ADA compliant when installed to the specific requirements of these regulations.

ADA permits a parallel approach to wet bars.