

## Features

- 36" (914 mm) minimum base cabinet width
- Large/medium bowls
- 9-1/2" (241 mm) depth provides generous workspace
- Smart Divide® feature offers a lower bowl divider that increases workspace versatility
- Versatile design allows large bowl to be installed on the right or left
- No faucet holes; requires wall- or deck-mount faucet
- Matte finish offers rich, dimensional color



## Material

- KOHLER Neoroc® composite is durable and built to withstand day-to-day cleaning tasks
- Solid color throughout the sink
- Heat-resistant up to 750°F
- Scratch-, stain-, chip-, and thermal-shock-resistant

## Installation

- Undermount
- Easy to install in a one-person, single-day project

## Recommended Products/Accessories

K-8801 Sink drain and strainer with tailpiece  
K-8799 Sink drain and strainer basket  
K-23726 Drain treatment  
K-23730 Neoroc® cleaner

## Optional Products/Accessories

K-11352 Disposal Flange with Stopper  
K-9000 P-Trap

## Included Components

K-5198 Sink Rack  
K-5655 Sink Rack

## Codes/Standards







CSA B45.5/IAPMO Z124

## KOHLER® Neoroc® Sinks Lifetime Limited Warranty

See website for detailed warranty information.

## Available Colors/Finishes

*Color tiles intended for reference only.*

Color	Code	Description
	CM6	Matte White
	CM7	Matte Graphite
	CM1	Matte Black
	CM2	Matte Brown
	CM3	Matte Taupe
	CM4	Matte Grey

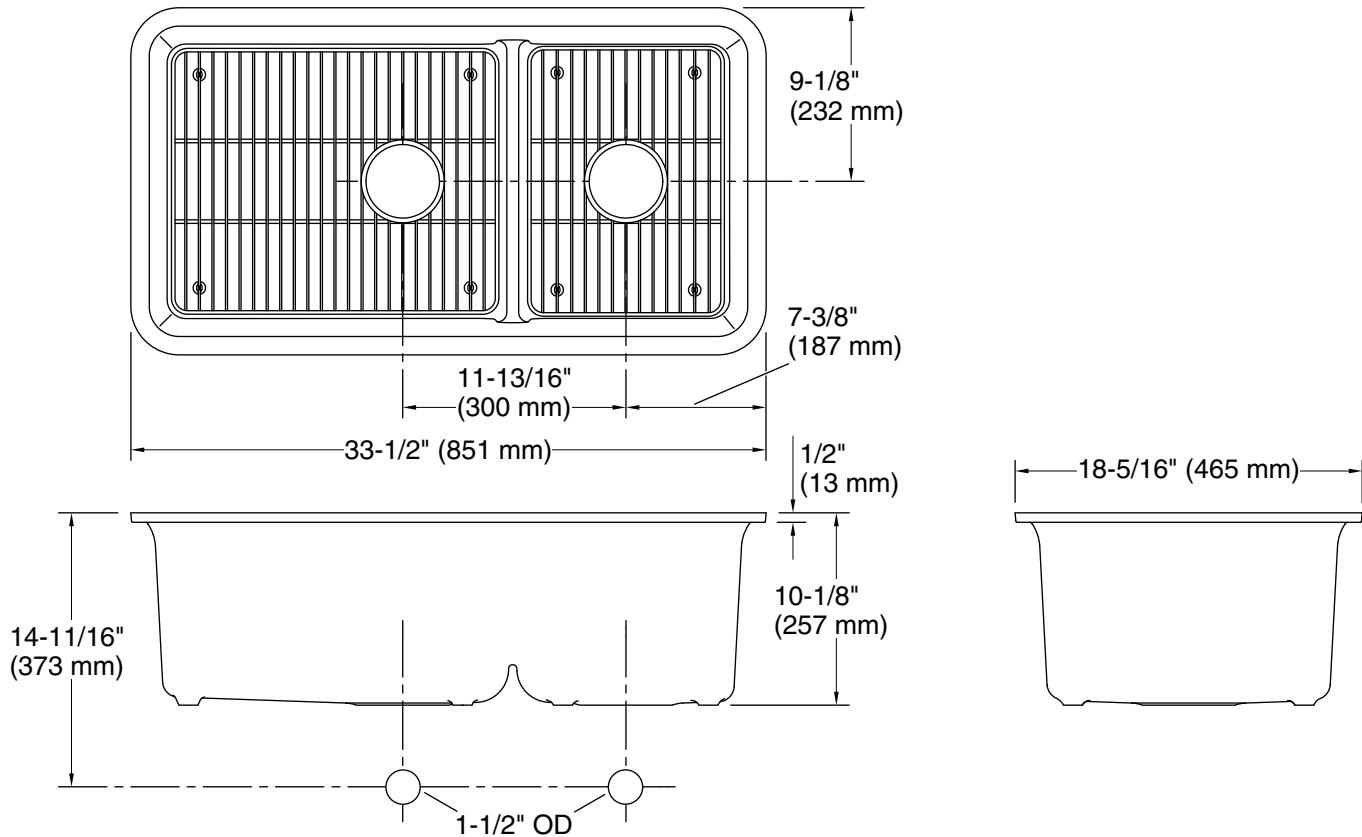

## Technical Information

All product dimensions are nominal.

Bowl configuration: Off-set Large/small

Min. base cabinet width: 36" (914 mm)

Bowl area (Left): Length: 18-5/16" (465 mm)  
 Width: 15-3/8" (391 mm)  
 Bowl depth: 9-1/2" (241 mm)  
 Water depth: 4-1/2" (114 mm)

Bowl area (Right): Length: 11-5/8" (295 mm)  
 Width: 15-3/8" (391 mm)  
 Bowl depth: 9-1/2" (241 mm)  
 Water depth: 4-1/2" (114 mm)

With overflow: No

Drain hole: 3-7/8" (98 mm)

Template: Undermount, 1256394-7, required, included

## Notes

Install this product according to the installation instructions.