

Features

- 30" (762 mm) minimum base cabinet width
- Single bowl
- 12" (305 mm) depth provides generous workspace
- Offset drain increases workspace in the sink and storage space underneath
- Accessories stack and slide on ledges for a custom arrangement
- Wash bin features a deep tub, perfect for washing and soaking household items
- Stainless steel utility rack fits securely within the wash bin
- Matte finish offers rich, dimensional color
- No faucet holes; requires wall- or deck-mount faucet

Material

- KOHLER Neoroc® composite is durable and built to withstand day-to-day cleaning tasks
- Solid color throughout the sink
- Heat-resistant up to 750°F
- Scratch-, stain-, chip-, and thermal-shock-resistant

Installation

- Undermount
- Easy to install in a one-person, single-day project

Recommended Products/Accessories

- K-8801 Sink drain and strainer with tailpiece
- K-8799 Sink drain and strainer basket
- K-23726 Drain treatment
- K-23725 Cast iron cleaner

Optional Products/Accessories

- K-11352 Disposal Flange with Stopper
- K-9000 P-Trap

Included Components

- K-27788 Stainless steel utility rack
- K-27789 Wash bin



Codes/Standards







CSA B45.5/IAPMO Z124

KOHLER® Neoroc® Sinks Lifetime Limited Warranty

See website for detailed warranty information.

Available Colors/Finishes

Color tiles intended for reference only.

Color	Code	Description
	CM6	Matte White
	CM7	Matte Graphite
	CM2	Matte Brown
	CM3	Matte Taupe
	CM1	Matte Black
	CM4	Matte Grey

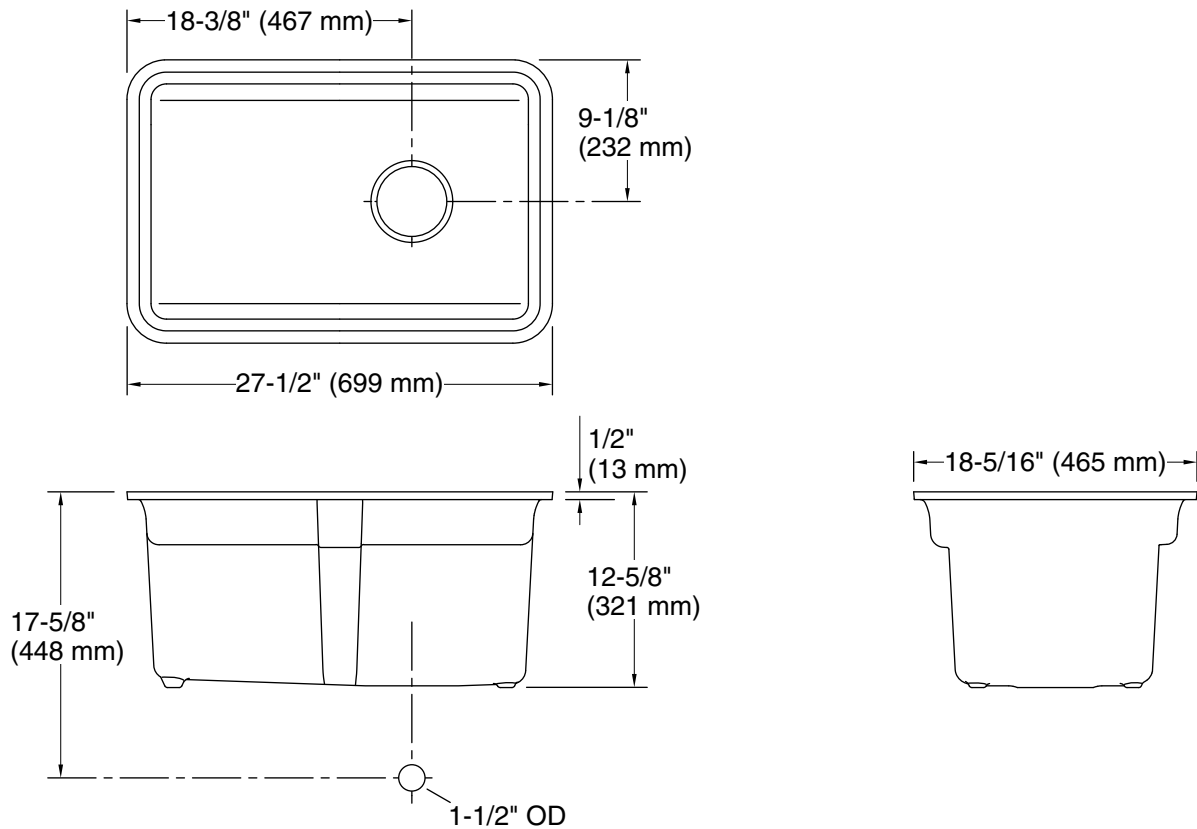

Technical Information

All product dimensions are nominal.

Bowl configuration: Single

Min. base cabinet width: 30" (762 mm)

Bowl area (Only): Length: 24-3/8" (620 mm)
 Width: 15-3/8" (391 mm)
 Bowl depth: 12" (305 mm)
 Water depth: 12" (305 mm)

With overflow: No

Drain hole: 3-7/8" (98 mm)

Template: Undermount, 1311528-7, required, included

Notes

Install this product according to the installation instructions.

NOTICE: Countertop manufacturer or cutter must use the cut-out template provided with the product, or a current one provided by Kohler Co. (call 1-800-4-KOHLER). Kohler Co. is not responsible for cutout errors when the incorrect cut-out template is used.