



Iron/Tones®
Smart Divide® 33" top-/undermount double-bowl
kitchen sink
K-6625

Features

- 33" (838 mm) minimum base cabinet width for top-mount installation
- 36" (914 mm) minimum base cabinet width for undermount installation
- Large/medium bowls
- 9" (229 mm) depth provides generous workspace
- Smart Divide® feature offers a lower bowl divider that increases workspace versatility
- Versatile design allows large bowl to be installed on the right or left

Material

- KOHLER® enameled cast iron

Installation

- Top-mount or undermount

Recommended Products/Accessories

- K-5137 Sink Rack
- K-5139 Sink rack
- K-23726 Drain treatment
- K-23725 Cast iron cleaner
- 1411886 Undermount sink kit 23"

Optional Products/Accessories

- K-11352 Disposal Flange with Stopper
- K-9000 P-Trap



Codes/Standards









ASME A112.19.1/CSA B45.2

KOHLER® Enameled Cast Iron Kitchen and Bathroom Sink Lifetime Limited Warranty

See website for detailed warranty information.

Available Colors/Finishes

Color tiles intended for reference only.

Color	Code	Description
	0	White
	FF	Sea Salt™
	96	Biscuit
	NY	Dune
	95	Ice™ Grey
	58	Thunder™ Grey
	7	Black Black™
	TRF	Truffle

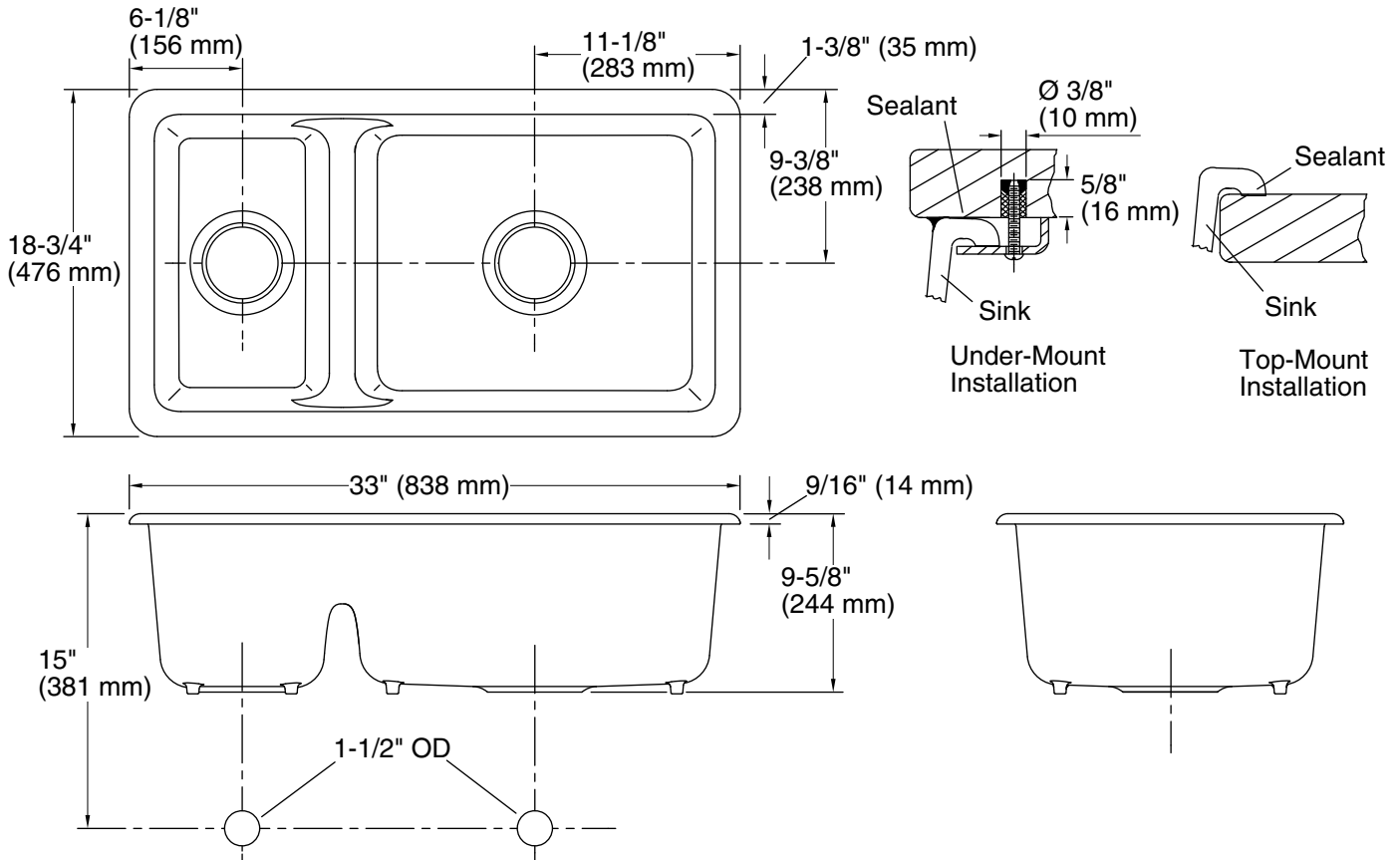

Technical Information

All product dimensions are nominal.

Bowl configuration: Off-set Large/small

Min. base cabinet width: 36" (914 mm)

Bowl area (Right): Length: 19-1/4" (489 mm)
Width: 16" (406 mm)
Bowl depth: 9" (229 mm)
Water depth: 9" (229 mm)

Bowl area (Left): Length: 9-1/4" (235 mm)
Width: 16" (406 mm)
Bowl depth: 9" (229 mm)
Water depth: 9" (229 mm)

Drain hole: 3-7/8" (98 mm)

Template: 1043168-7, required, included

Notes

Install this product according to the installation instructions.

NOTICE: The countertop manufacturer or cutter must use the cut-out template provided with the product, or a current one provided by the Kohler Co. (Call 1-800-4-KOHLER.) Kohler Co. is not responsible for cut-out errors when the incorrect cut-out template is used.