

Features

- 36" minimum base cabinet width
- Single bowl
- 5-1/4" depth
- Bowl slopes toward drain to minimize water pooling
- Offset drain increases workspace in the sink and storage space underneath
- Three faucet holes and one accessory hole to the right

Material

- KOHLER® enameled cast iron

Installation

- Top-mount

Recommended Products/Accessories

- K-6237 Left-Bowl Sink Rack
- K-6255 Right-Bowl Sink Rack
- K-8801 Sink drain and strainer with tailpiece
- K-8799 Sink drain and strainer basket
- K-23726 Drain treatment
- K-23725 Cast iron cleaner

Optional Products/Accessories

- K-11352 Disposal Flange with Stopper
- K-9000 P-Trap



ADA

Codes/Standards

ASME A112.19.1/CSA B45.2
ADA
ICC/ANSI A117.1



KOHLER® Enameled Cast Iron Kitchen and Bathroom Sink Lifetime Limited Warranty

See website for detailed warranty information.

Available Colors/Finishes

Color tiles intended for reference only.

Color Code Description

	0	White
	96	Biscuit
	7	Black Black™

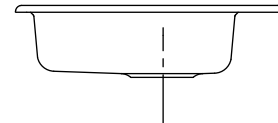
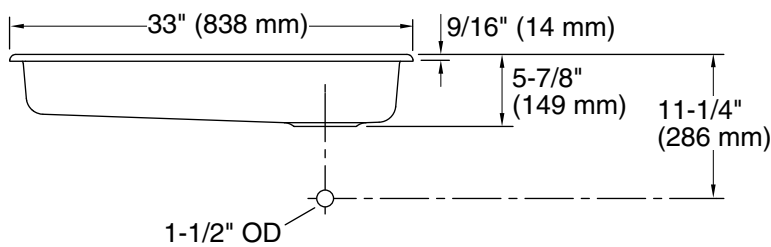
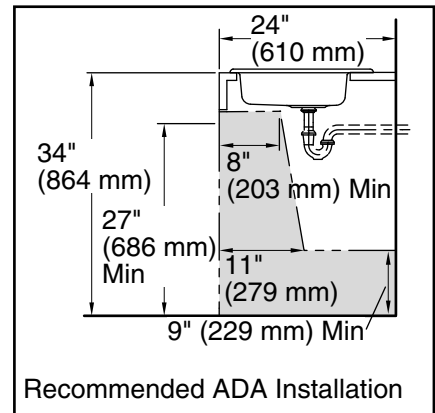
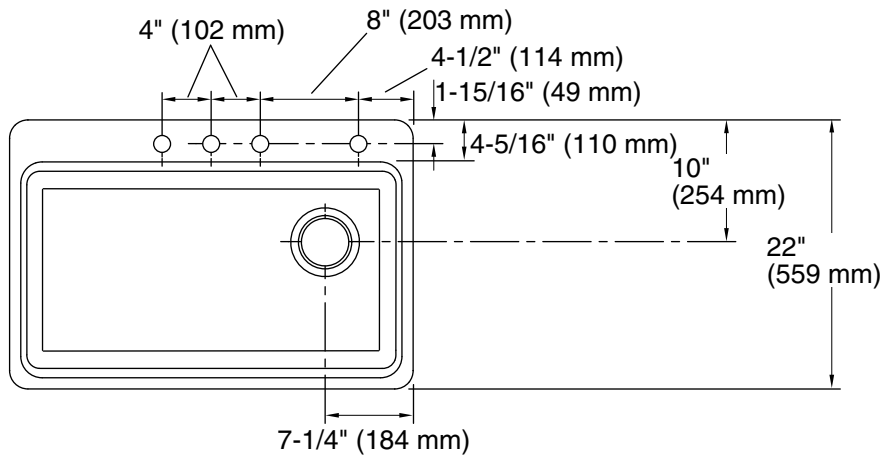

Technical Information

All product dimensions are nominal.

Bowl configuration: Single

Center(s): 4

Min. base cabinet width: 33" (838 mm)

Bowl area (Only): Length: 30-1/4" (769 mm)
 Width: 17-1/4" (438 mm)
 Bowl depth: 5-1/4" (133 mm)
 Water depth: 5-1/4" (133 mm)

Faucet hole spacing: 4" (102 mm)

Template: 1166727-7, required, included

Notes

Install this product according to the installation instructions.

ADA compliant when installed to the specific requirements of these regulations.