

Features

- 28" minimum base cabinet width
- Single bowl
- 9" (229 mm) depth provides generous workspace
- Five oversized faucet holes
- Oversized holes allow for easy installation of faucets and accessories
- Bowl slopes toward drain to minimize water pooling
- Offset drain increases workspace in the sink and storage space underneath
- Small size fits compact spaces
- Sink drain with strainer sold separately

Material

- KOHLER® enameled cast iron

Installation

- Undermount
- Undermount installation kit not included

Recommended Products/Accessories

- K-6238 Sink Rack
- K-8801 Sink drain and strainer with tailpiece
- K-8799 Sink drain and strainer basket
- K-6194 Utility Rack With Soaking Cup
- K-6239 Colander with Cutting Board
- K-6246 Maple hardwood cutting board
- K-11352 Disposal Flange with Stopper
- K-9000 P-Trap
- 1411886 Undermount sink kit 23"
- K-23726 Drain treatment
- K-23725 Cast iron cleaner

Included Components

- K-6238 Sink Rack



Codes/Standards









ASME A112.19.1/CSA B45.2

KOHLER® Enameled Cast Iron Kitchen and Bathroom Sink Lifetime Limited Warranty

See website for detailed warranty information.

Available Colors/Finishes

Color tiles intended for reference only.

| Color | Code | Description |
|---|------|---------------|
|  | 0 | White |
|  | FF | Sea Salt™ |
|  | 96 | Biscuit |
|  | NY | Dune |
|  | 95 | Ice™ Grey |
|  | 58 | Thunder™ Grey |
|  | 7 | Black Black™ |
|  | TRF | Truffle |

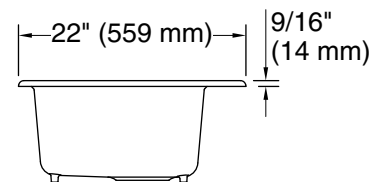
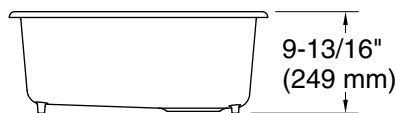
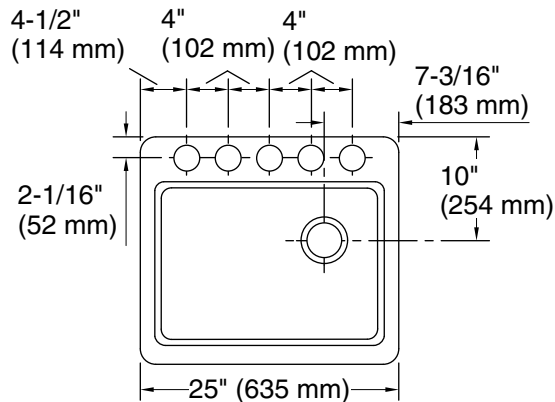

Technical Information

All product dimensions are nominal.

| | |
|--------------------------|--|
| Bowl configuration: | Single |
| Min. base cabinet width: | 28" (711 mm) |
| Bowl area (Only): | Length: 22-1/4" (565 mm) Width: 15-13/16" (402 mm) Bowl depth: 9" (229 mm) |
| Number of deck holes: | 5 |
| Faucet hole(s): | 2-3/8" (60 mm) |
| Drain hole: | 3-7/8" (98 mm) |
| Template: | 1172565-7, required, included |

Notes

Install this product according to the installation instructions.

NOTICE: Countertop manufacturer or cutter must use the cut-out template provided with the product, or a current one provided by Kohler Co. (call 1-800-4-KOHLER). Kohler Co. is not responsible for cutout errors when the incorrect cut-out template is used.

IMPORTANT! Use of the colander, wood cutting board, and utility rack requires the "reveal" cutout option on the cutout template.