

Features

- Globular glass shades are gracefully suspended from curved metal bases in artist-inspired arrangements
- A great piece for almost any space — especially in a foyer or dining room
- Requires five bulbs with G9 sockets; G9 LED bulbs recommended (sold separately)
- Suitable for damp locations, per UL 1598
- Includes installation hardware

Material

- Manufactured with quality materials and complemented with a meticulous finishing process
- Durable finishes engineered to last and designed to coordinate with KOHLER faucet finishes



Codes/Standards

UL 1598
CSA C22.2 No. 250.0

KOHLER® Indoor Lighting Fixtures Limited Warranty

See website for detailed warranty information.

Available Colors/Finishes

Color tiles intended for reference only.

Color	Code	Description
-------	------	-------------

	BLL	Matte Black
---	-----	-------------

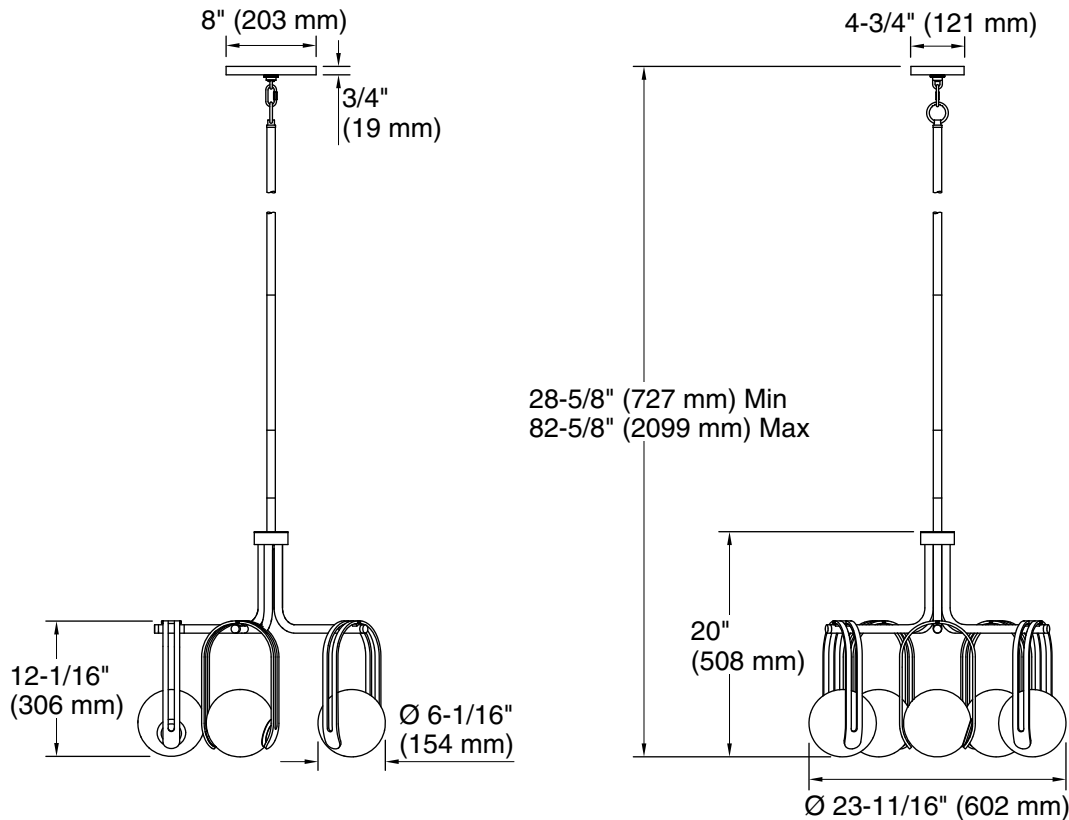

Required Electrical Service

One circuit required.

120 V, 60 Hz

Technical Information

All product dimensions are nominal.

Material:	Steel, Aluminum, Glass
Number of Lights:	5
Lighting Type:	Socket-based
Socket Type:	2 pin G9
Number of Shades:	5
Shade Type:	Glass - frosted
Hanging Type:	Downrod
Downrod Detail:	2 x 18" (457 mm), 1 x 12" (305 mm), 1 x 6" (152 mm), 1 x 3" (76 mm)
Height:	28-5/8" (728 mm) - 82-5/8" (2099 mm)