



Iron/Impressions®

31" Enameled cast iron vanity top with integrated rectangular sink

K-3049-1

Features

- Single faucet hole
- Sloped-wall rectangular basin
- Combines with standard 30" (762 mm) vanities and 29" (737 mm) iron console tables

Material

- KOHLER® enameled cast iron

Installation

- Vanity top

Recommended Products/Accessories

K-9018 P-Trap
K-23726 Drain treatment
K-23725 Cast iron cleaner



Codes/Standards









ASME A112.19.1/CSA B45.2

KOHLER® Enameled Cast Iron Kitchen and Bathroom Sink Lifetime Limited Warranty

See website for detailed warranty information.

Available Colors/Finishes

Color tiles intended for reference only.

Color	Code	Description
	0	White
	FF	Sea Salt™
	96	Biscuit
	NY	Dune
	95	Ice™ Grey
	FT	Basalt
	7	Black Black™
	GRL	Grey Lavender
	PLM	Black Plum

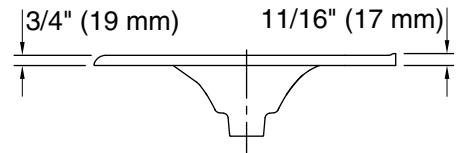
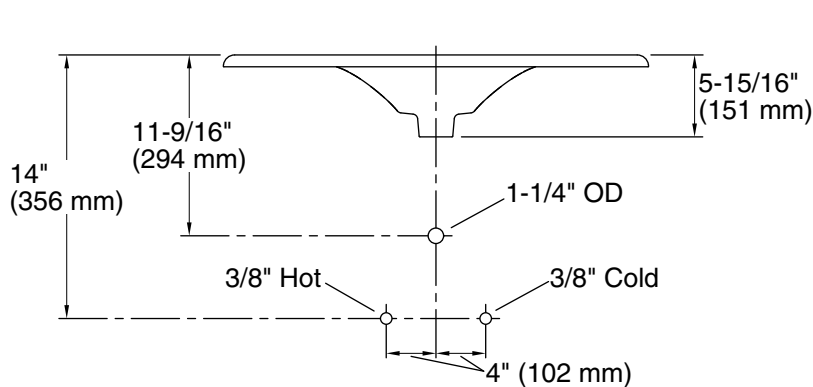
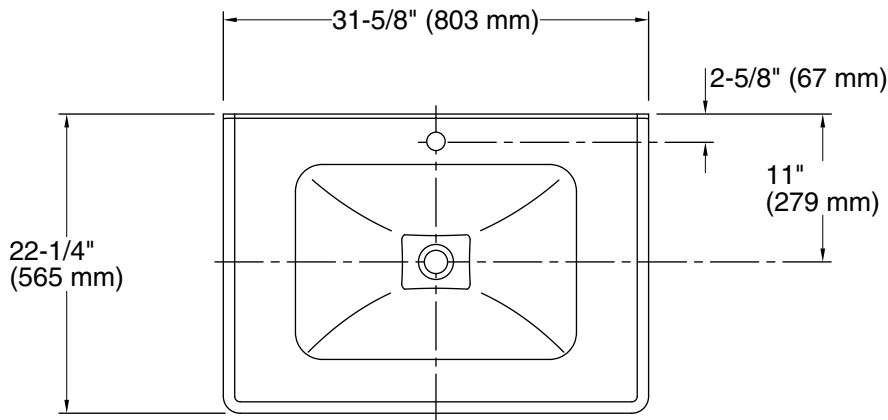

Technical Information

All product dimensions are nominal.

- Bowl configuration: Single
- Bowl area (Only): Length: 20-7/8" (530 mm)
 Width: 14-1/2" (368 mm)
 Water depth: 4" (102 mm)
- Number of deck holes: 1
- Faucet hole(s): 1-3/8" (35 mm)
- Drain hole: 1-3/4" (44 mm)

Notes

Install this product according to the installation instructions.

NOTE: When selecting a faucet for this bathroom sink, ensure the faucet has a spout reach of 4-1/2" (114 mm) to 5" (127 mm) and has a spout height of 3" (76 mm) to 6" (152 mm).

Product does not have an overflow.