



Devonshire®

20-1/2" oval undermount bathroom sink
K-2336

Features

- Oval basin
- Overflow drain
- No faucet holes; requires wall- or counter-mount faucet
- Coordinates with other products in the Devonshire collection

Material

- Vitreous china

Installation

- Undermount

Recommended Products/Accessories

- K-9018 P-Trap
- K-23726 Drain treatment
- K-23725 Cast iron cleaner

Included Components

- 1193643 Basin clamps



ADA

CSA B651

Codes/Standards



ASME A112.19.2/CSA B45.1
ADA
ICC/ANSI A117.1
CSA B651

KOHLER® One-Year Limited Warranty

See website for detailed warranty information.

Available Colors/Finishes

Color tiles intended for reference only.

Color	Code	Description
	0	White
	96	Biscuit
	7	Black Black™

1-800-4KOHLER (1-800-456-4537)

Kohler Co. reserves the right to make revisions without notice to product specifications.

For the most current Specification Sheet, go to www.kohler.com.

11-11-2023 01:14 - US/CA

THE BOLD LOOK
OF **KOHLER®**

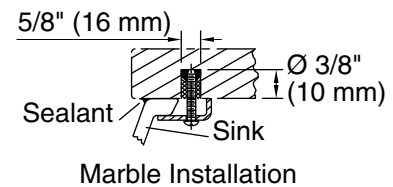
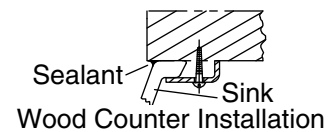
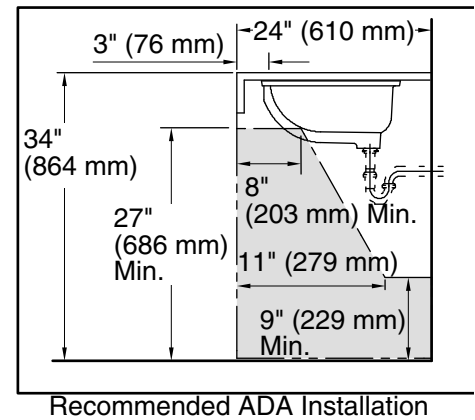
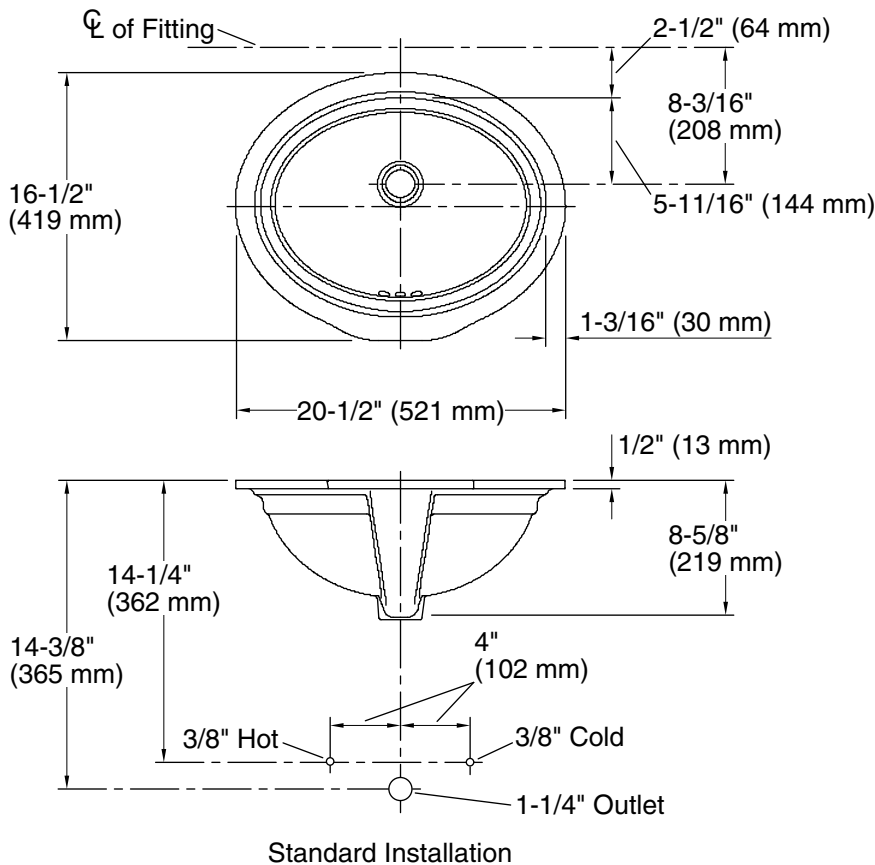

Technical Information

All product dimensions are nominal.

Bowl configuration:	Single
Bowl area (Only):	Length: 18-1/8" (460 mm) Width: 14" (356 mm) Water depth: 4-3/16" (106 mm)
With overflow:	Yes
Drain hole:	1-3/4" (44 mm)
Template:	1050263-7, required, not included

Notes

Install this product according to the installation instructions.

NOTICE: Countertop manufacturer or cutter must use the current product template available at www.kohler.com, or by calling 1-800-4KOHLER. Kohler Co. is not responsible for cutout errors when the incorrect cutout template is used.

ADA, CSA B651 compliant when installed to the specific requirements of these regulations.