



# Iron/Impressions®

37" Enameled cast iron vanity top with integrated oval sink

## K-3051-1

### Features

- Single faucet hole
- Elongated oval basin
- Combines with standard 36" (915 mm) vanities to create a complete sink

### Material

- KOHLER® enameled cast iron

### Installation

- Vanity top

### Recommended Products/Accessories

- K-9018 P-Trap
- K-23726 Drain treatment
- K-23725 Cast iron cleaner



### Codes/Standards









ASME A112.19.1/CSA B45.2

### KOHLER® Enameled Cast Iron Kitchen and Bathroom Sink Lifetime Limited Warranty

See website for detailed warranty information.

### Available Colors/Finishes

*Color tiles intended for reference only.*

Color	Code	Description
	0	White
	FF	Sea Salt™
	96	Biscuit
	NY	Dune
	95	Ice™ Grey
	FT	Basalt
	7	Black Black™
	DGB	Indigo Blue

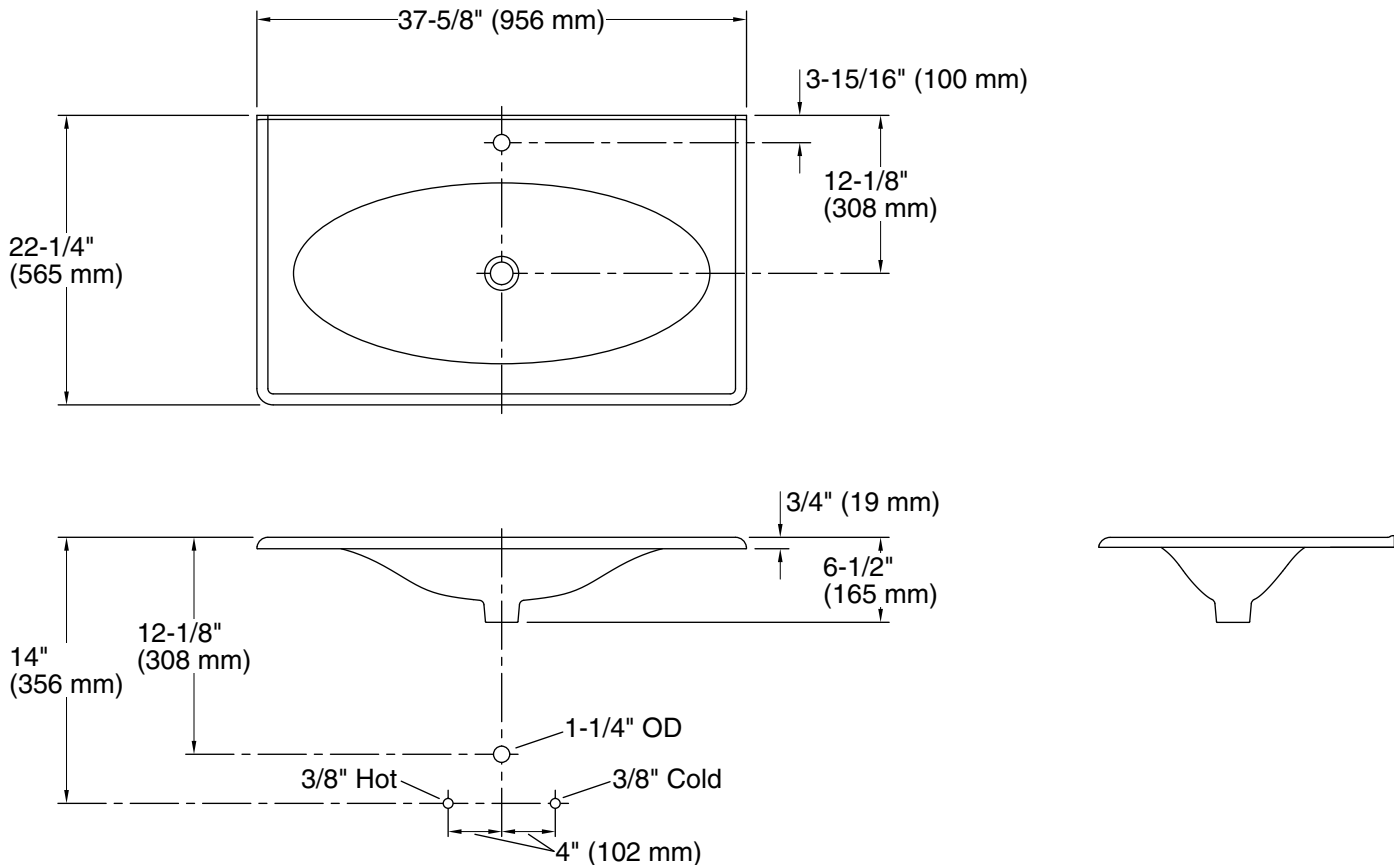

### Technical Information

All product dimensions are nominal.

Bowl configuration:	Single
Bowl area (Only):	Length: 32" (813 mm) Width: 13-7/8" (352 mm)
Number of deck holes:	1
Faucet hole(s):	1-3/8" (35 mm)
Drain hole:	1-3/4" (44 mm)

### Notes

Install this product according to the installation instructions.

NOTE: When selecting a faucet for this bathroom sink, ensure the faucet has a spout reach of 4-1/2" (114 mm) to 5" (127 mm) and has a spout height of 3" (76 mm) to 6" (152 mm).

Product does not have an overflow.