

## Features

- Deep rectangular basin in translucent glass with rippled texture
- No faucet holes; requires wall- or counter-mount faucet
- Glass material provides a strong durable surface that is easy to clean yet visually distinctive
- The Inia sink is available in clear glass (Ice), translucent colors, and opaque colors

## Material

- Glass

## Installation

- Drop-in

## Recommended Products/Accessories

- K-23726 Drain treatment
- K-23723 Faucet cleaner
- K-7107 Decorative Drain



ADA

## Codes/Standards







CSA B45.11/IAPMO Z401  
ADA  
ICC/ANSI A117.1

## KOHLER® One-Year Limited Warranty

See website for detailed warranty information.

## Available Colors/Finishes

*Color tiles intended for reference only.*

Color	Code	Description
	B11	Ice
	TG1	Translucent Dusk
	TG2	Translucent Dew
	TG3	Translucent Doe
	TG6	Translucent Sapphire
	TG7	Translucent Sandalwood
	TG8	Translucent Stone

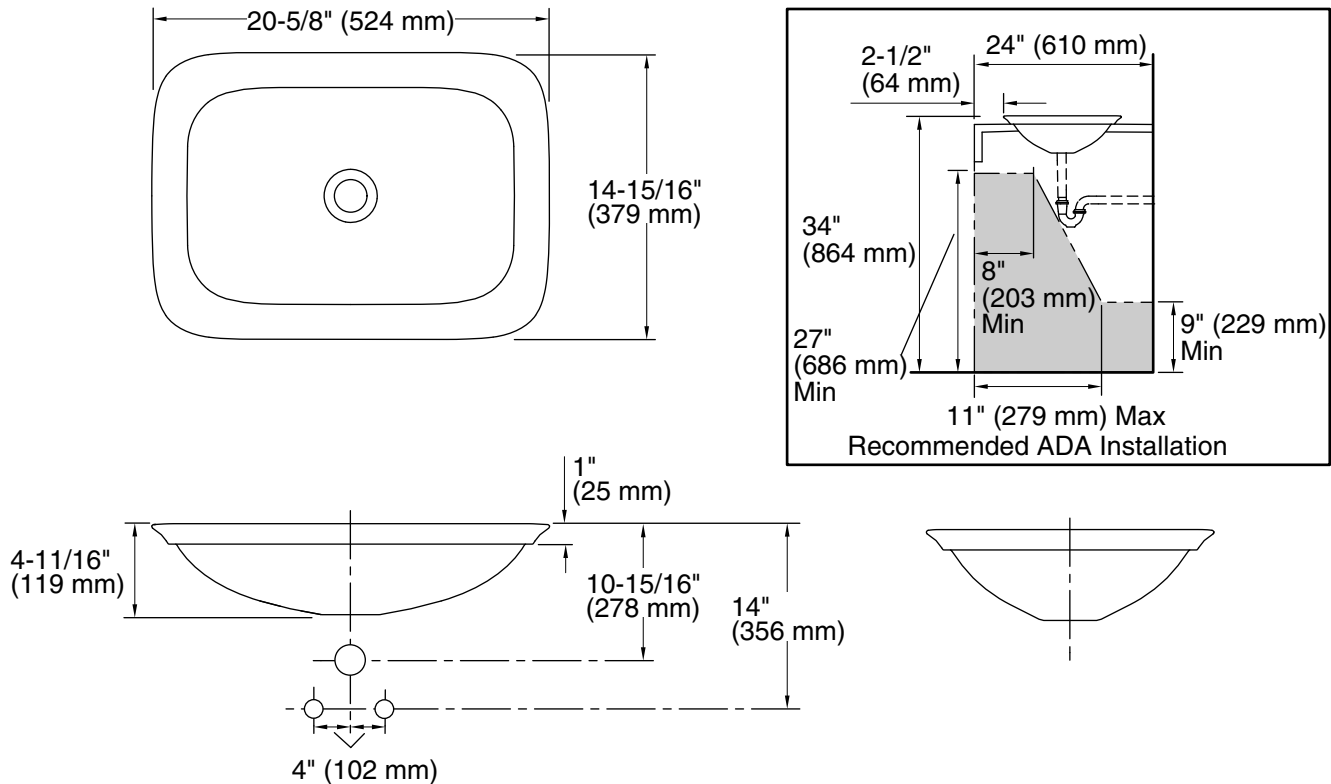

### Technical Information

All product dimensions are nominal.

Bowl area (Only):	Length: 20-1/8" (511 mm)
	Width: 14-3/8" (366 mm)
	Bowl depth: 3-7/8" (99 mm)
With overflow:	No
Template:	1190263-7, not required, included

### Notes

Install this product according to the installation instructions.

Product does not have an overflow.

NOTICE: Countertop manufacturer or cutter must use the cut-out template provided with the product, or a current one provided by Kohler Co. (call 1-800-4KOHLER). Kohler Co. is not responsible for cut-out errors when the incorrect cut-out template is used.

Product must be installed with the supplied drain gasket kit.

ADA compliant when installed to the specific requirements of these regulations.